

SANYO

INSTRUCTION MANUAL

Facsimile Transceiver

SFX-110 SFX-210



Warning

1. This apparatus is suitable for connection to the following:

- Direct Exchange Lines (DEL's) to the British Telecom (BT) or Hull Public Switched Telephone Network (PSTN) which require signalling in either loop disconnect (LD) or multi-frequency (MF) tones.
- Any compatible Private Branch Exchange (PBX) accepting signalling in either loop disconnect (LD) or multi-frequency (MF) tones. A definition of a relevant branch exchange can be found in BS6789 Sect 6.1 Clause 2.4.

Provision is made for the connection of a telephone instrument via the apparatus, which is connected when the apparatus is not in use.

This apparatus is NOT suitable for connection to the following:

- Shared service (party lines)
- 1 + 1 Carrier Systems
- As an extension to a payphone

2. The supplier of the apparatus should be consulted for an up to date list of PBX's with which the apparatus is compatible. If the appropriate PBX extension wiring is not already installed, it must be installed by BT, or where the extension wiring is not owned by BT, by the authorized maintainer of the PBX, unless the authorised maintainer has been given 14 days written notice that extension wiring and/or sockets are to be installed by another person.

It cannot be guaranteed that this apparatus will operate correctly under all possible conditions of connection to compatible PBX's.

Any cases of difficulty should be referred in the first instance to the apparatus supplier.

The compatible PBX may or may not be a type which provides secondary proceed indication.

3. This apparatus has been approved for the use of the following facilities:

- Storage of Telephone Numbers for retrieval by predetermined code
- Automatic Call Initiation
- Operation in the absence of Proceed Indication
- Automatic Dialing Facilities
- Automatic Answering Facilities
- Built-in Digital Answering System Facilities (only for SFX-210)
- Automatic Storage of Last Number Dialed
- Repeat Attempt Facilities
- Loud Speaking Facilities
- Simple Telephone Facilities
- Conversation on hold Facilities
- Series Connection
- Auto Clear from the call originating end
- Modem
- Handsfree speakerphone facilities (only for SFX-210)

Any other usage will invalidate the approval of the apparatus if as a result it then cases to comply with the standards against which approval was granted.

4. One touch and speed dial numbers stored in the memory should be checked after initial programming or after a loss of power.

-
5. This apparatus may only be connected to lines not listed in telephone directories issued by public network operators when used in the auto answer mode, and that the telephone number should not be made public unless accompanied by suitable instructions concerning incoming calls, i.e. listed as a facsimile number.
 6. Customer Guide to REN

The ringer equivalence number (REN) is a measure of apparatus performance when used with other equipment connected to the same telephone line.

The sum of the individual REN's for all equipment to be connected to a single line should not exceed the maximum REN allowed, namely 4.

The REN of this apparatus is 3.

Consequently only one telephone for which the REN is 1, may be connected to the same line as this apparatus. A BT provide telephone instrument may be assumed to have a REN of 1, unless otherwise marked.
 7. The voltage drop introduced by the apparatus between the PSTN and the associated telephone at a current of 40 mA d.c. is 350 mV.
 8. Notice should be taken that caller are accustomed to calls being answered normally within about 10s, and that the majority abandon calls that are not answered in 45s.
 9. This facsimile equipment is series apparatus and only one such apparatus is allowed to be connected between the PSTN and the main apparatus. The main apparatus may be an approved telephone or telephone answering machine or a combination of the two.
 10. 999 can be dialed on the handset for the purpose of making outgoing calls to the BT emergency (999) service.

Customer Notification

Before connecting this equipment to a British Telecom line, the lower portion of this form should be sent to your local Telephone Area Sales Office. (See Telephone Directory)



I/We request the installation of socket (New Style)

Customer Name

Address

Post Code

Telephone Number

SFX-110: APPROVED CERTIFICATE NO. 503796

SFX-210: APPROVED CERTIFICATE NO. 503795

Special Installation Instructions

Customers Signature Data



Precautions

Placement precautions

- Avoid placing the unit in humid or dusty places, or in places where it will be exposed to excessive heat (direct sunlight, heaters, etc.).
- Do not step on or set anything on the AC cord. **DAMAGE TO THE AC CORD IS A SAFETY RISK AND CAN CAUSE A FIRE.**
- Install the unit only on a stable surface.
- Do not connect the unit in the same AC power wall outlet as appliances that generate large amounts of interference (heaters with thermostats, appliances with motors, etc.). It is best to use a completely separate electrical outlet.
- Keep the unit away from water. If water accidentally enters the unit, unplug the power cord immediately. **DO NOT PLUG THE UNIT AGAIN.** Contact an authorized Sanyo service center or dealer.

Handling precautions

- Do not remove any parts that are held in place with screws. (The unit does not contain any user-serviceable items.)
- Maintain standard room temperature 5°C-35°C (41°F-95°F) during use. Do not subject the unit to shock or vibration. Do not move the unit while it is in use.
- A rapid increase in room temperature in cool weather can cause condensation to form inside the unit. If this happens, wait at least 15 minutes after turning the unit on before attempting to operate it. Failure to do so may result in paper jams and/or poor print quality.
- When cleaning the cover or operation panel of the unit, wipe gently using a damp cloth to which a small amount of a neutral detergent has been added. **NEVER USE SOLVENTS OR CHEMICALLY TREATED CLOTHS.**

Introduction

Thank you for purchasing the SFX-110/210. This facsimile transceiver has many outstanding features, including:

Fax features

- 10-page automatic document feed
- Automatic paper cutter
- 3 resolution modes (fine/superfine/standard)
- 16-shade halftone
- Timer transmission
- Polling reception
- Overseas transmission mode
- Automatic redial
- Accept/refuse selective reception
- 30-meter roll of recording paper
- Compatible with plain-paper quality thermal paper

Phone/Dialing Features

- Mercury button to use Mercury Residential Telephone/Fax Service
- Built-in digital answering system with time/date stamp (only for SFX-210)
- 28-number automatic dialing memory
- Dial Bank to store the 20 most frequently called numbers
- Answering System connection ready (only for SFX-110)
- Speakerphone for handsfree telephone conversation (only for SFX-210)
- Automatic switching between telephone, fax and answering system
- LCD display with 16-character line
- Built-in telephone handset

In order to use the SFX-110/210 effectively and keep it in good working order, read this instruction manual thoroughly and keep it for future reference.

Table of contents

Before use

Unpacking and accessories	5
Part names and functions	6
Operation panel for SFX-210	8
Operation panel for SFX-110	10
Installation	12
Telephone line and AC power connections	12
Dialing mode	14
Recording paper	15
Battery installation (only for SFX-210)	17
Copying (Confirming proper operation)	19

Phone use

Phone calls	20
Hold	23
Phone call when the power failure occurs	23
Redial	24
One-touch dial	25
Speed dial	26
Dial Bank	27

Fax use

Original documents	29
Transmission.....	30
Placing original documents	30
Contrast/Resolution	31
Manual transmission	32
Automatic transmission	33
Redial	34
Overseas transmission.....	35
Timer transmission	36
Reception	38
Auto reception mode	39
Manual reception mode	41
Answer reception mode	42
Remote reception	44
Polling reception	45
Selective reception.....	46
Phone reservation	48
Diagnostic reports	49

Answering System (only for SFX-210)

Digital answering system	50
Playing messages	51
Erasing messages	52
Automatic message erase	53
Remote operation	54
Password programming	55
Message recording modes	56
Toll saver setting	57
Resetting answering system	59

Programming Functions

Entering names	60
Programming dialing memory	62
One-touch dial programming	62
Speed-dial programming	64
Printing a number list	67
Dial Bank editing	68
Calendar and clock	70
Header print (Setting your station name and fax number)	71
Activity report	73
Feature switches	75
Feature switch list	77
Printing a feature switch list	79

Mercury residential service

Mercury residential service	80
Cost center codes	80
Programming your Mercury key for Mercury PIN code service	81
Making a test call (Mercury PIN code service)	83
Clearing the Mercury key (Mercury PIN code service)	84
Programming your Mercury key for Residential 132	85
Making a test call (Mercury Residential 132)	86
Programming Mercury key to one-touch and speed dial memory	87
Making calls via Mercury	88
Making a phone call via Mercury	88
Making a phone call on a PABX	90
Transmission via Mercury	91

Maintenance

Thermal paper handling	92
Jammed original / Jammed recording paper	93
Mechanical error	94
Cleaning	95
Troubleshooting	97

Specifications	99
-----------------------------	----

Unpacking and accessories

To unpack the SFX-110/210:

1. Remove the accessories (handset, recording paper roll, etc.) from carton.
2. Remove the fax machine along with the foam braces on both sides.
3. Remove the plastic wrapping around the fax machine.
4. Remove the transportation tapes.
5. Save the carton and the foam braces for later storage and/or shipping.
6. Place the unit where there is access to an AC outlet and a modular phone jack.
(Be sure to observe the precautions found on page 1.)

Accessories

Make sure the accessories listed below are included with the unit.

Accessories (included with machine)

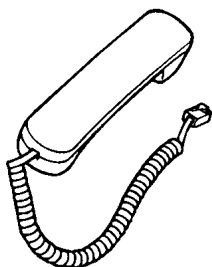

- Handset
- Instruction manual

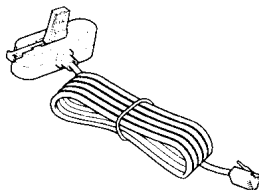

- Telephone line cord
- Backup battery (only for SFX-210)

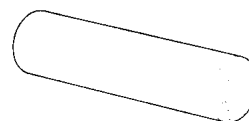

- Thermal paper

Part names and functions

Front view

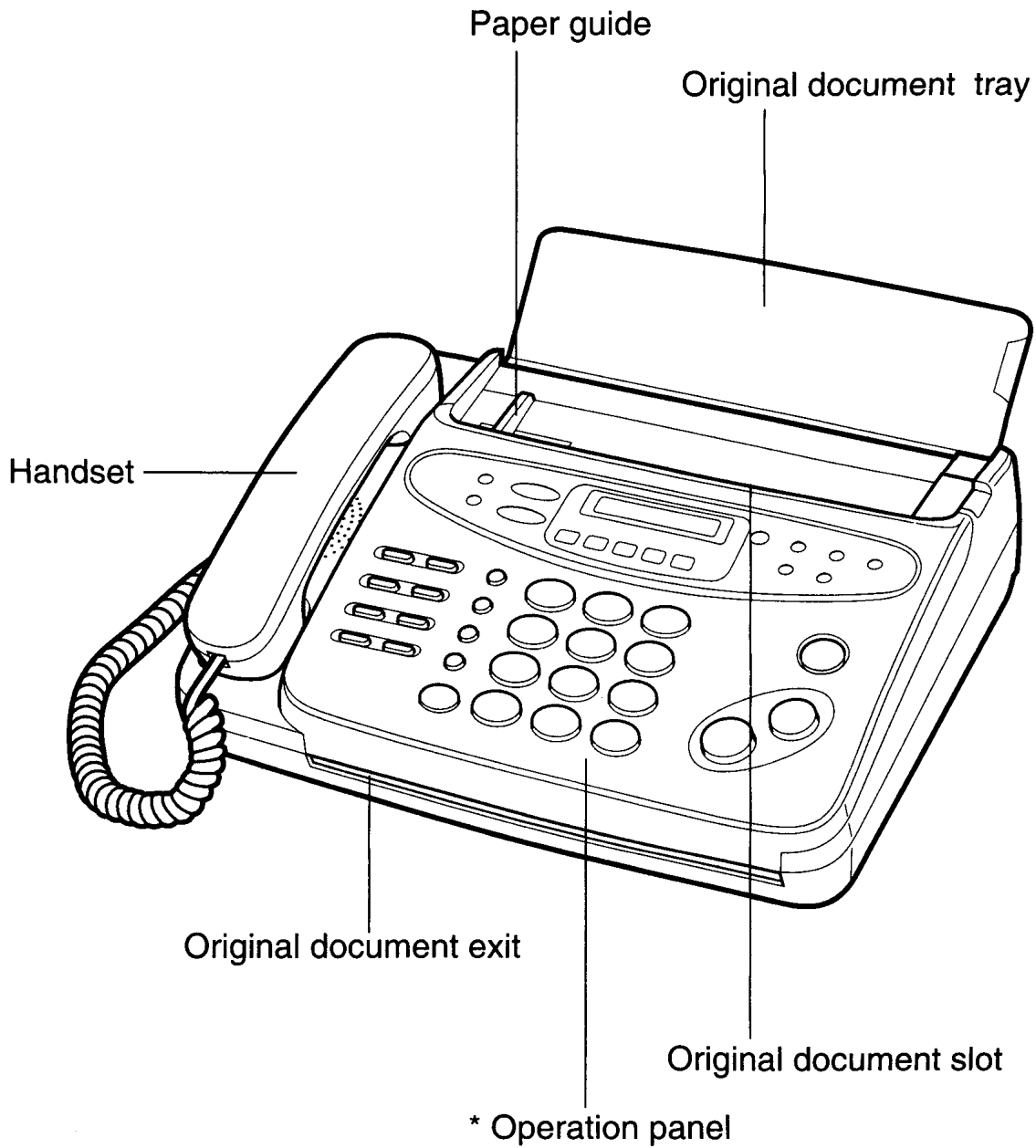

* Illustrations of the operation panel used in this manual are for the SFX-210, unless otherwise specified.

Rear view and left side

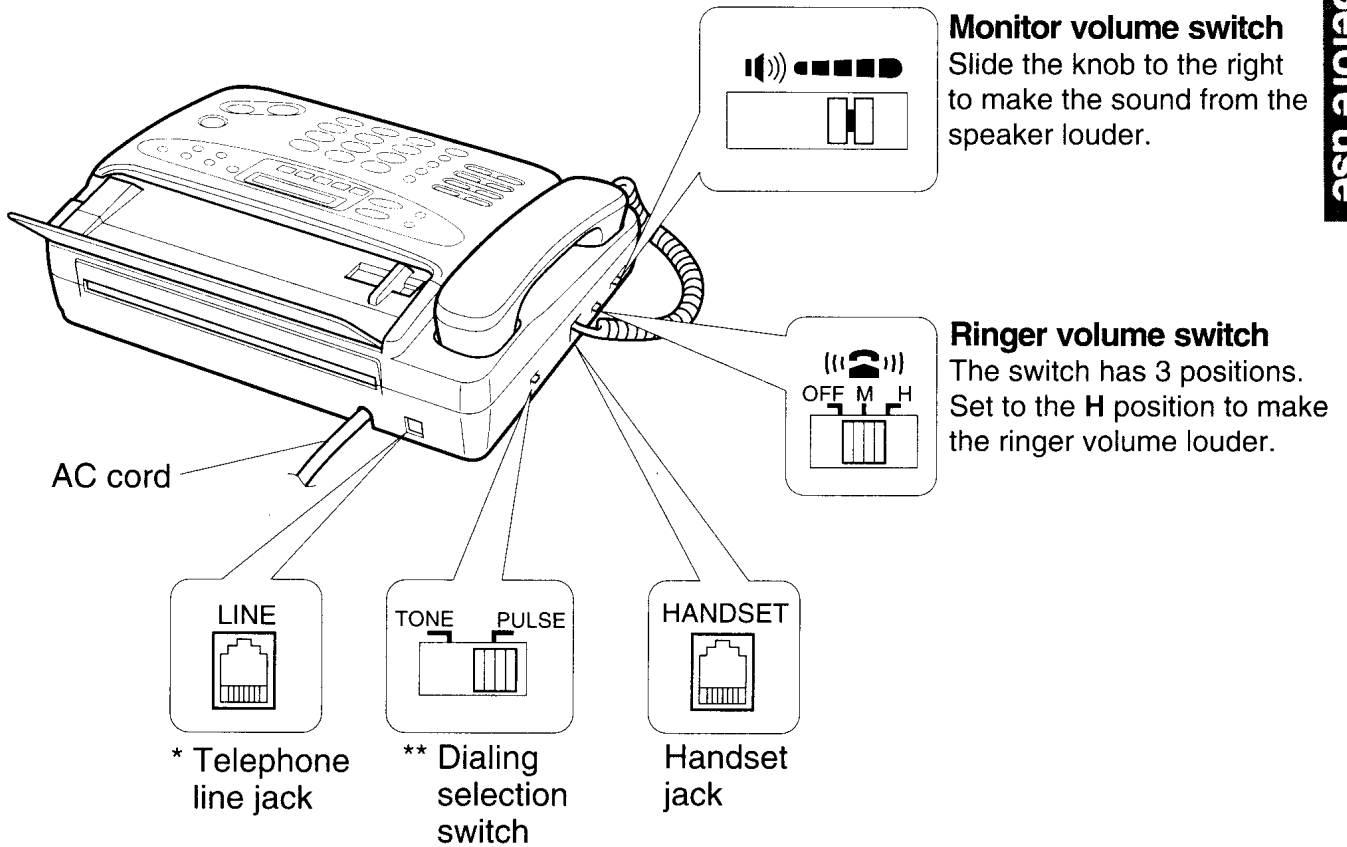

- *: An extension phone or an answering machine (only for SFX-110) can be connected through the telephone line jack on the back of the unit.
- ** : This dialing selection switch is effective only for emergency call when the AC power is interrupted.

Inner view

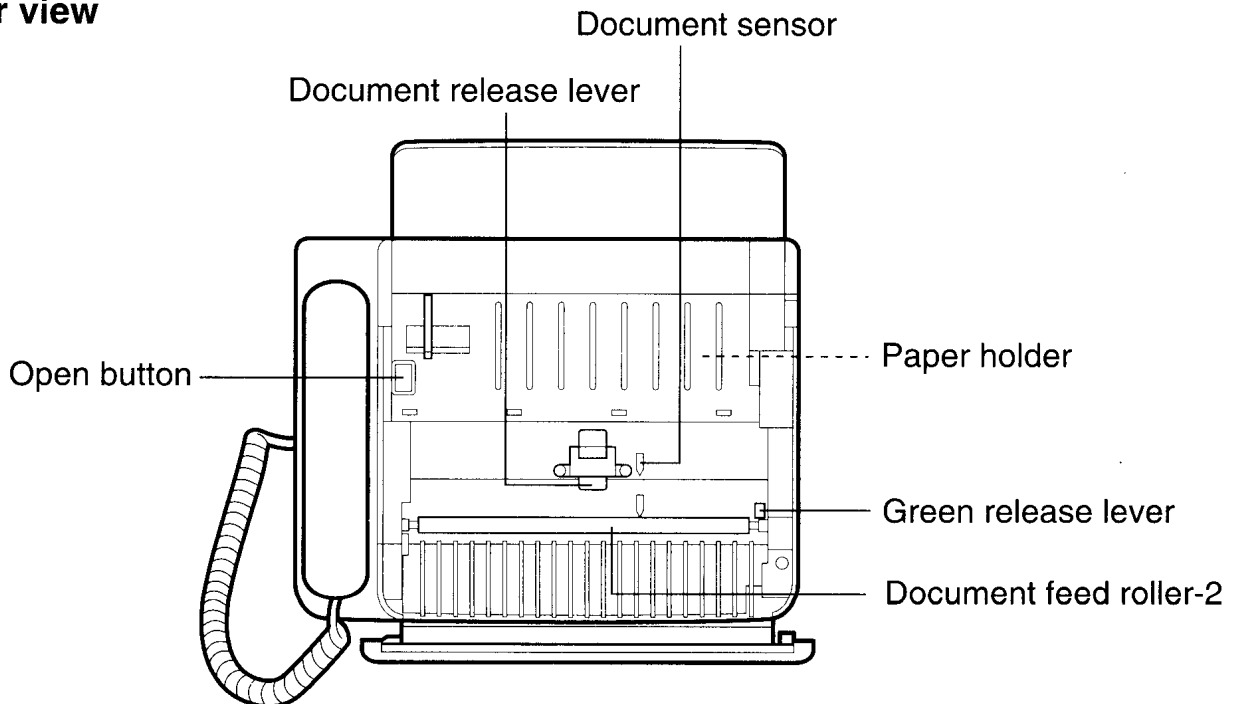

Operation panel for SFX-210

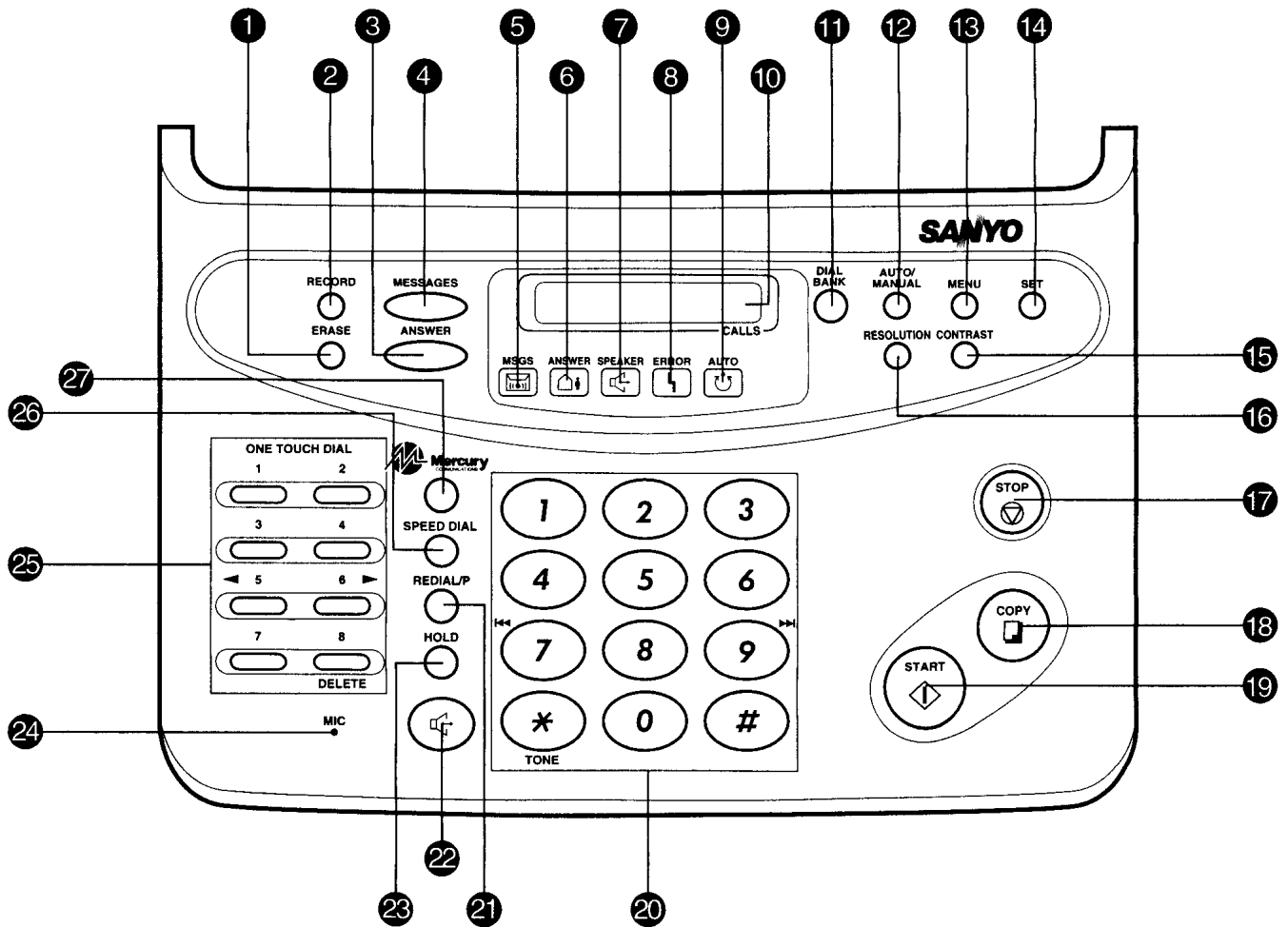

1. [ERASE] key	• Press this key to erase incoming messages recorded in the built-in answering system.
2. [RECORD] key	• Press this key to record your greeting.
3. [ANSWER] key	• Press this key to set reception mode to ANSWER.
4. [MESSAGES] key	• Press this key to play the recorded messages.
5. MSGS lamp	• Lights when the messages are recorded.
6. ANSWER lamp	• Lights when the unit is set to ANSWER reception mode.
7. SPEAKER lamp	• Lights when [🔊] key is pressed.
8. ERROR lamp	• Lights if a communication error occurs.
9. AUTO lamp	• Lights when the unit is set to AUTO reception mode.

10. Display	<ul style="list-style-type: none"> Shows calendar and clock functions, operation prompts.
11. [DIAL BANK] key	<ul style="list-style-type: none"> Press this key to review phone numbers stored in the Dial Bank memory.
12. [AUTO/MANUAL] key	<ul style="list-style-type: none"> Press this key to switch between AUTO and MANUAL reception mode.
13. [MENU] key	<ul style="list-style-type: none"> Press this key when selecting various functions.
14. [SET] key	<ul style="list-style-type: none"> Press this key to confirm selections.
15. [CONTRAST] key	<ul style="list-style-type: none"> Press this key to select contrast settings.
16. [RESOLUTION] key	<ul style="list-style-type: none"> Press this key to select resolution settings.
17. [STOP] key	<ul style="list-style-type: none"> Press to interrupt transmission/reception/copying or to turn off the ERROR lamp. Press to cancel any programming/dialing procedure and to remove an original document that has been placed in the tray.
18. [COPY] key	<ul style="list-style-type: none"> Press to make a copy and to print a list or report.
19. [START] key	<ul style="list-style-type: none"> Press to start transmission or manual reception.
20. Number keys 0-9,#, *	<ul style="list-style-type: none"> These keys are used to dial fax and phone numbers and to change various functions.
21. [REDIAL/P] key	<ul style="list-style-type: none"> Press this key to redial the last number dialed. Press this key to insert a pause between two digits in a number being dialed.
22. [📞] (speaker key)	<ul style="list-style-type: none"> Allows you to have conversation without using the handset.
23. [HOLD] key	<ul style="list-style-type: none"> Temporarily places a call on hold.
24. Microphone	<ul style="list-style-type: none"> Used for recording your greeting. Also used for handsfree speakerphone conversation.
25. One-touch keys	<ul style="list-style-type: none"> Frequently dialed numbers can be stored in memory using these 8 keys. Also used in programming. [5]: ◀ (moves cursor one to the left.) [6]: ▶ (moves cursor one to the right. Also functions as the ENTER key in name programming.) [8]: DELETE (functions as DELETE key.)
26. [SPEED DIAL] key	<ul style="list-style-type: none"> Press this key when using speed dial.
27. [Mercury] key	<ul style="list-style-type: none"> Press this key to dial the number via Mercury.

Operation panel for SFX-110

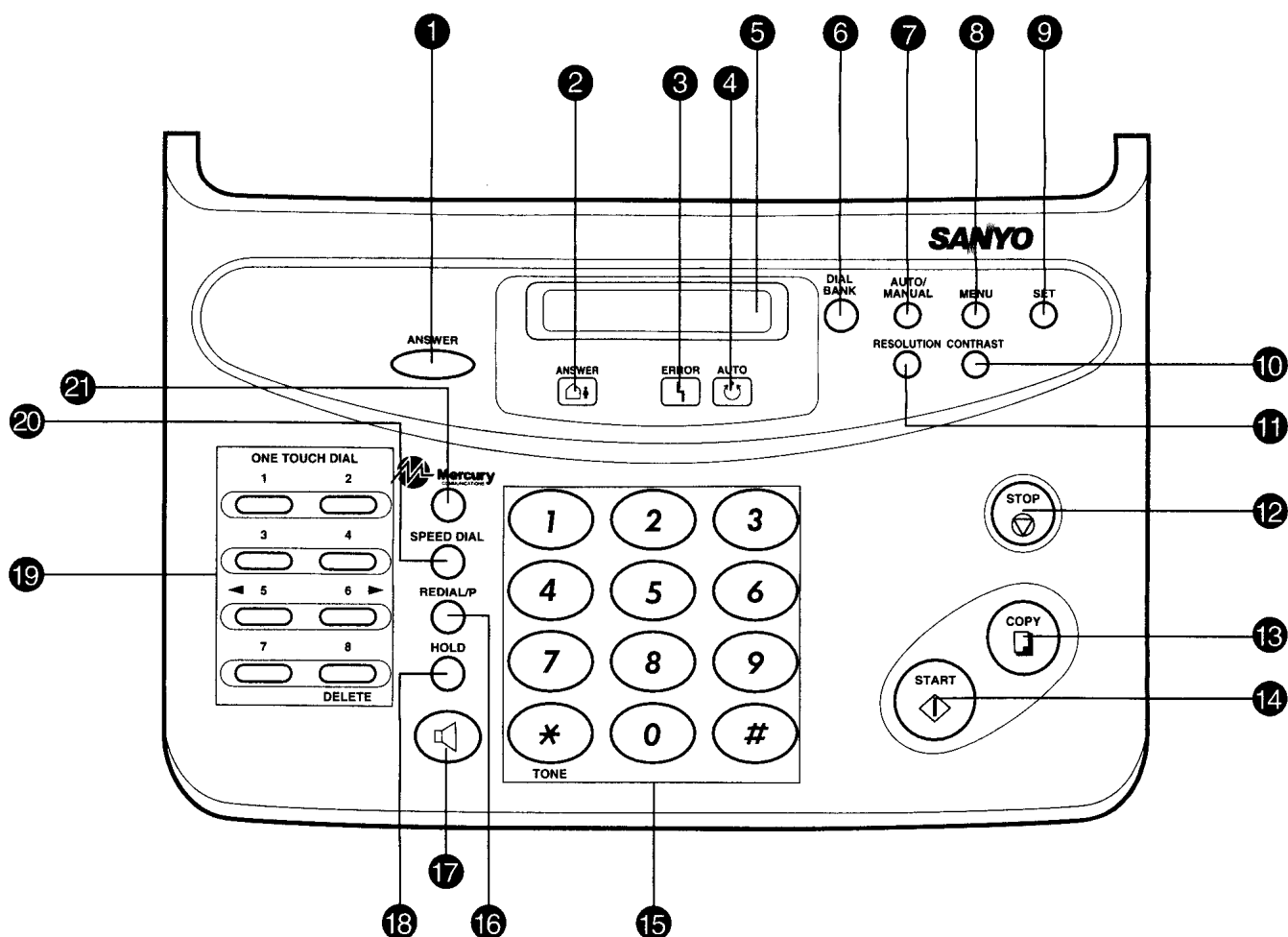

1. [ANSWER] key	• Press this key to set reception mode to ANSWER.
2. ANSWER lamp	• Lights when the unit sets to ANSWER mode.
3. ERROR lamp	• Lights if a communication error occurs.
4. AUTO lamp	• Lights when the unit sets to AUTO mode.
5. Display	• Shows calendar and clock functions, operation guidance, machine status, etc.
6. [DIAL BANK] key	• Press this key to dial the number stored in dial bank memory.
7. [AUTO/MANUAL] key	• Press this key to select a reception mode AUTO or MANUAL.

8. [MENU] key	<ul style="list-style-type: none"> • Press this key when selecting various functions.
9. [SET] key	<ul style="list-style-type: none"> • Press this key to confirm selections.
10. [CONTRAST] key	<ul style="list-style-type: none"> • Press this key to select contrast settings.
11. [RESOLUTION] key	<ul style="list-style-type: none"> • Press this key to select resolution settings.
12. [STOP] key	<ul style="list-style-type: none"> • Press to interrupt transmission/reception/copying or to stop the ERROR lamp lighting. • Press to cancel various setting and dialing functions and to remove an original document that has been placed in the unit.
13. [COPY] key	<ul style="list-style-type: none"> • Press this key to make a copy.
14. [START] key	<ul style="list-style-type: none"> • Press to start transmission or manual reception.
15. Number keys 0-9,#, *	<ul style="list-style-type: none"> • These keys are used to dial fax and phone numbers and to change various functions.
16. [REDIAL/P] key	<ul style="list-style-type: none"> • Press this key to redial the last number dialed. • Press this key to insert a pause between two digits in a number being dialed.
17.  (Speaker key)	<ul style="list-style-type: none"> • Allows you to monitor a call without using the handset.
18. [HOLD] key	<ul style="list-style-type: none"> • Temporarily places a call on hold.
19. One-touch keys	<ul style="list-style-type: none"> • Frequently dialed numbers can be stored in memory using these 8 keys. • Also used in programming. <ul style="list-style-type: none"> [5]: ◀ (moves cursor 1 to the left.) [6]: ▶ (moves cursor 1 to the right. Also functions as ENTER key in name programming.) [8]: DELETE (functions as DELETE key.)
20. [SPEED DIAL] key	<ul style="list-style-type: none"> • Press this key when using speed dial.
21. [Mercury] key	<ul style="list-style-type: none"> • Press this key to dial the number via Mercury.

Telephone line and AC power connections

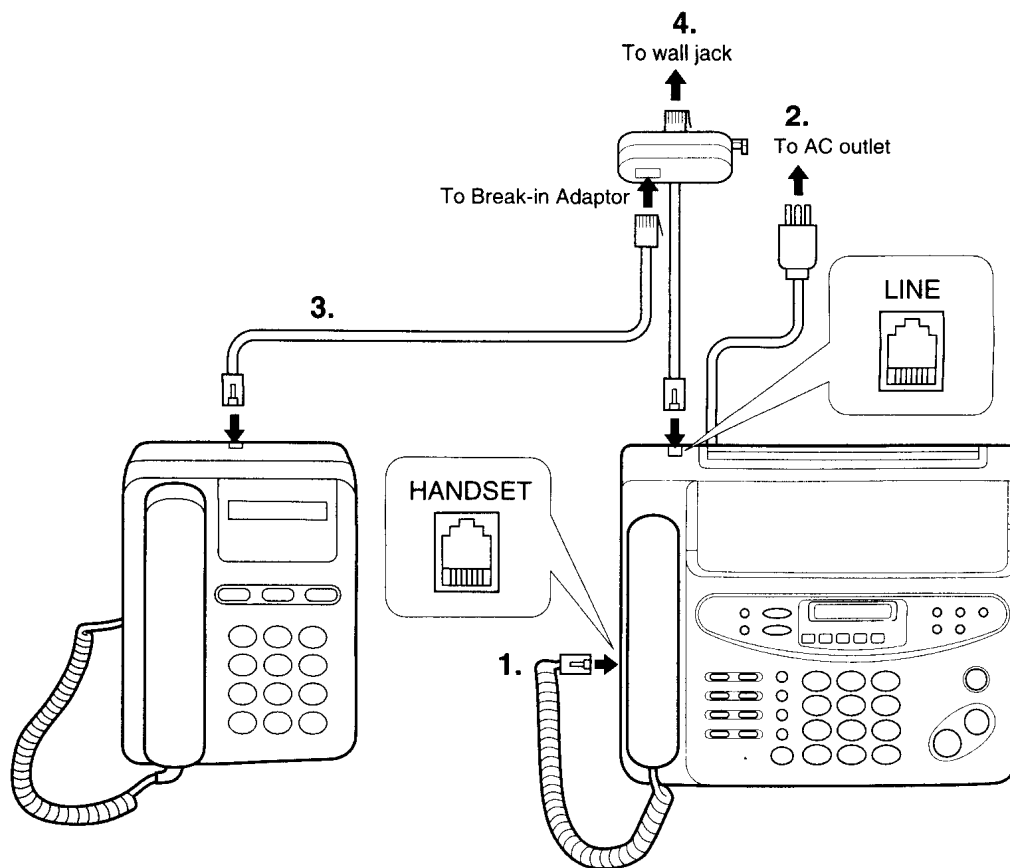

1. Connect the handset cord into the **HANDSET** jack.
2. Connect AC power cord of the SFX-110/210 into an AC wall outlet.
 - The AC outlet shall be installed near the equipment and shall be easily accessible.
3. An extension telephone or an answering machine (only for SFX-110) can be connected through the Break-in Adaptor.
4. Line connection
For line connection the LJU connector may be plugged into a suitable socket.

Note:

- If you have custom calling services that produce tones or clicks during line use (such as Call Waiting), some difficulty may be experienced in the operation of your fax unit. Consult your telephone company.

Caution:

- Never install telephone wiring during a lightning storm.
- Never install telephone jacks in wet locations unless the jack is specifically designed for wet locations.
- Never touch uninsulated telephone wires or terminals unless the telephone line has been disconnected at the network.
- Use caution when installing or modifying telephone lines.
- Avoid using a telephone (other than a cordless type) during an electrical storm. There may be a remote risk of electric shock from lightning.
- Do not use the telephone to report a gas leak in the vicinity of the leak.

Connection of Associated Apparatus.

An associated telephone/apparatus should be connected only via the socket on the break in adaptor fitted.

Series connection of this apparatus will introduce a voltage drop of 0.35V at 40mA. This apparatus should not be used in conjunction with other series connected apparatus such that the aggregate declared voltage drops of all this apparatus, together with the voltage drop introduced at 40mA by any separate wiring that is used to link items of apparatus, exceeds 2V.

Difficulty may occasionally be experienced when making calls to the PSTN via the series apparatus.

such difficulties may includedifficulty in making calls
.....problems in telephone conversation being experienced by both parties to the call

Should difficulties be experienced consult the supplier or maintainer of the series apparatus, not the network operator.

Dialing mode

The SFX-110/210 has been factory-set to the PULSE (10PPS) dialing mode.

If your telephone line uses TONE dialing, you must change the dialing mode setting using the feature switch No. 00.

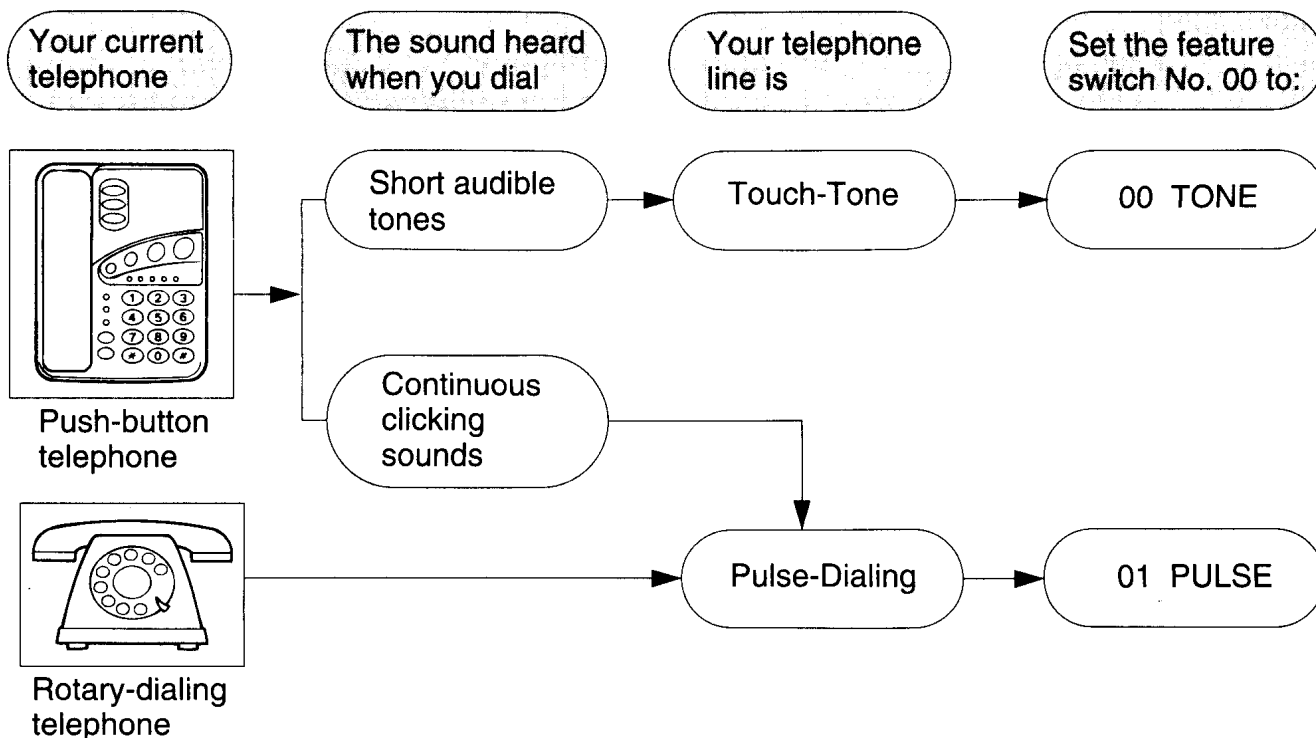

• If you are still not sure which dialing system your telephone line uses, contact your telephone company.

To change dialing mode to TONE:

1. Press **[MENU]** 4 times.

SFX-210: 4 : SET FAX MODE ?

SFX-110: 4 : SET MODE ?

2. Press **[SET]**.

1 : SET TIME ?

3. Press **[MENU]** twice.

3 : FEATURE SW. ?

4. Press **[SET]**.

(00) DIAL MODE

5. Press **[SET]**.

10 PPS (01)

6. Enter **[0]** and **[0]** to select the TONE mode.

TONE (00)

7. Press **[SET]**.

(05) TIMER REDIAL

8. Press **[STOP]** twice to return to standby mode.

SFX-210: 26 Jun. 12:00 00

SFX-110: 26 Jun. '96 12:00

Recording paper

How to install the recording paper roll:

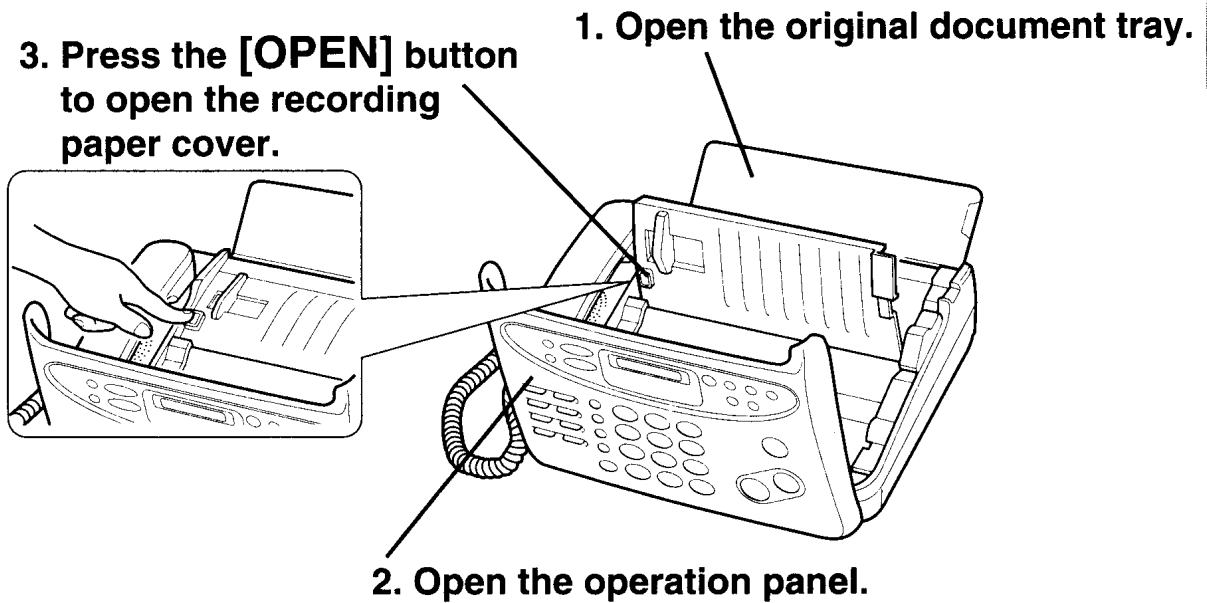

4. Place the supplied roll, in the direction shown in the diagram, in the paper holder.

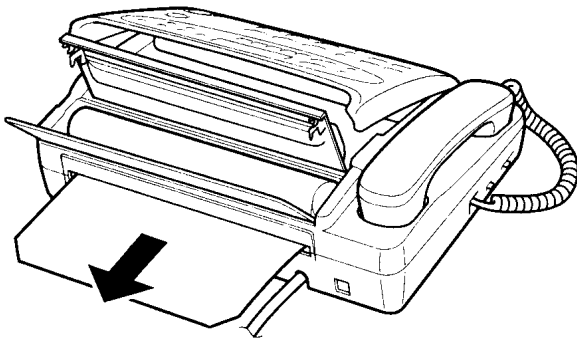
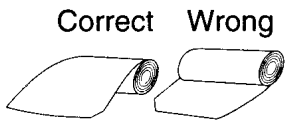

5. Remove any slack from the roll and insert the end of roll into the recording paper exit until it extends about 10 cm.

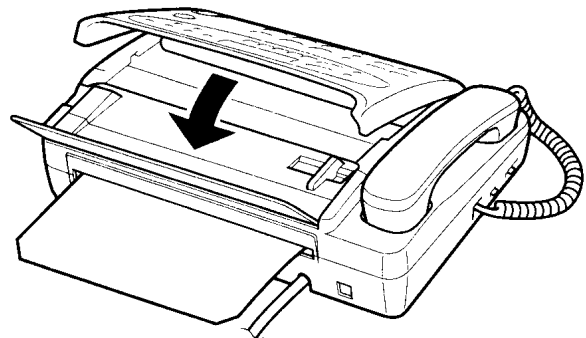

6. Close the recording paper cover by pressing both left and right corners of the far end of the cover firmly. The SFX-110/210 cuts the extra recording paper automatically.

-
- Use only the recording paper specified for the SFX-110/210.

High-grade thermal paper

The SFX-110/210 is compatible with high-grade thermal paper, a new type of fax recording paper that has plain-paper quality. Unlike regular thermal paper, the high-grade thermal paper does not fade with time, can be written on with pencil and can be erased.

SANYO Type: 3RE2182800450, 216 mm (8.5") wide and 25 m (82') long.

Thermal paper

SANYO Type: R-4079448-1, 216 mm (8.5") wide and 30 m (98') long.

To purchase, contact your dealer.

Battery installation (only for SFX-210)

The SFX-210 has a battery backup function to protect recorded greeting and messages from a power interruption. A fresh 9 V battery will be able to maintain the memory for up to 48 hours.

Before use

1. Remove the battery cover located bottom of the cabinet.

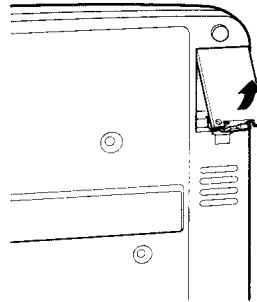

2. Connect the battery(supplied) to the wire as shown.

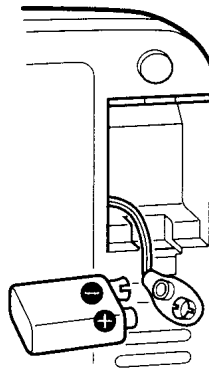

3. Place the battery into the holder.

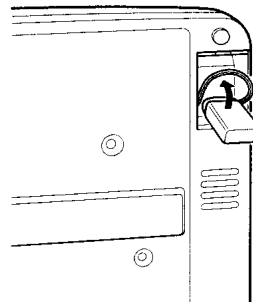

4. Replace the cover.

Time to replace the battery

When the battery needs to be replaced, a warning message appears intermittently on the display during standby mode.

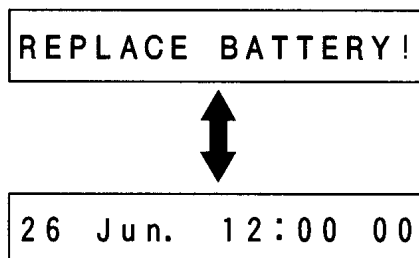

CAUTION

When installing the battery:

To prevent leakage from the battery, which is corrosive and can cause personal injury and damage to the unit, observe the following precautions:

1. The battery must be installed correctly. Match the polarities (+ and – signs) on the battery to the polarities of the battery holder.
2. If the unit is not to be used for an extended period of time, remove the battery from the unit.
3. Carefully follow the battery manufacturer's instructions for proper use and disposal.
4. **DO NOT ALLOW YOUNG CHILDREN TO HANDLE BATTERIES.**

NOTE: When the battery is discharged, it must be disposed of in a safe manner that complies with all applicable laws.

Copying (Confirming proper operation)

Make a copy to confirm that the unit is operating properly.

1. Place the original document face down.



STD NORMAL

Before use

2. Press [COPY].

*** COPY ***

- 3 After copying is completed, the recording paper is cut automatically.

SFX-210: 26 Jun. 12:00 00

SFX-110: 26 Jun. '96 12:00

• MEMO sheet

You can issue a blank sheet to write a memo.

Press [COPY] with no original inserted in the original document slot. The SFX-110/210 produces a blank memo sheet of about 10-cm (4") long. The MEMO sheet feature can also be used while the telephone is in use.

Phone calls

For SFX-210

Making phone call (using the speaker key)

1. Press [] (speaker key).

➔  lamp lights.

* SPEAKERPHONE *

2. Dial to the number you want to call.

Example: 111-2222

- To dial a number, you can use any of the following dialing methods:

One-touch dial (page 25)

Speed dial (page 26)

Using Dial Bank (page 27)

Using the **[REDIAL/P]** key (page 24)

Using the number keys

1 1 1 2 2 2 2

3. When the call is answered, speak towards the microphone.

- For the best sound quality, speak about 35 to 50 cm away from the microphone.
If the location is noisy, come closer to the microphone.

4. Press [] when the conversation is completed.

Answering a telephone call

1. The telephone rings.

Press [] (speaker key).

* SPEAKERPHONE *

2. Speak to the microphone.

3. Press [] again to hang up.

- If you do not wish to use the speakerphone feature, lift the handset to start and replace it to finish.

Tips for speaker key use

- Adjust the Monitor volume control on the left side of the unit to achieve the desired volume.
- If both parties talk at the same time, some part of conversation may be lost.
- If the speaker key is used in a noisy place, there may be momentary pauses in the conversation.
- To switch from the speaker key to the handset, simply lift the handset.
- If you hear an incoming fax tone at step 1, the SFX-210 receives the incoming fax automatically.
- The power cord must be connected to an electrical outlet for telephone calls to be placed from and received on the SFX-210.
- If you make a mistake when dialing a telephone number, press [, and start over.

For SFX-110

Making phone call (using the speaker key)

1. Press [] (speaker key) or lift the handset.

26 Jun. '96 12:00

2. Dial to the number you want to call.

Example: 111-2222

- To dial a number, you can use any of the following dialing methods:

One-touch dial (page 25)

Speed dial (page 26)

Using Dial bank (page 28)

Using the [REDIAL/P] key (page 24)

Using the number keys

1112222

3. When the call is answered, lift the handset and talk.

Answering a telephone call

1. The telephone rings.

Lift the handset.

2. Hang up when the conversation is completed.

Temporary Touch-Tone dialing access

Even if you have a pulse dialing line, you can temporarily change to Touch-Tone dialing to access special services such as electronic banking and remote-control answering machines.

1. Dial the number you want to call.

2. When your call is answered, press [*].

3. Enter the number required to access special services.

- The SFX-110/210 stays in tone mode until the call ends. Then it returns automatically to pulse mode.

Hold

1. Press [**HOLD**] during a telephone conversation.
The call is put on hold.

***	HOLD	***
-----	------	-----

2. If you are using handset, you can replace it.

3. Press [**HOLD**] or lift the handset to continue the conversation.

Phone use

-
- An extension phone user cannot talk with the caller while a call is on hold.
 - The SFX-110/210 has been factory-set with a music-on-hold feature (The music is Greensleeves). Use the feature switch No. 10 to turn off this feature (no music while a call is on hold). See pages 75-77 for detailed instructions.

Phone call when the power failure occurs

The SFX-110/210 is able to dial to the party when the power failure occurs. For using this feature, the dialing selection switch (see page 7) must be set to appropriate position.

Note:

- When you dial, press number keys firmly and confirm the dialing sound from the handset speaker.

Redial

The [REDIAL/P] key redials the last number dialed.

For SFX-210

1. Press [] (or lift the handset).

* SPEAKERPHONE *

2. Press [REDIAL/P].

➔ The last number dialed is redialed.

1 2 3

3. When the call is answered, speak toward the microphone.

For SFX-110

1. Press [] (or lift the handset).

26 Jun. '96 12:00

2. Press [REDIAL/P].

➔ The last number dialed is redialed.

1 2 3

3. When the call is answered, lift the handset and talk.

One-touch dial

This feature allows you to dial a stored number at the touch of a single key.

Before one-touch dialing can be used, the phone numbers of the parties must be programmed into memory. A maximum of 8 one-touch dialing numbers can be stored in memory.

(See pages 62-63 for programming instructions.)

To place a call using one-touch dialing buttons:

For SFX-210

1. Press [>] (or lift the handset).

* SPEAKERPHONE *

2. Press the one-touch key (1-8) for the party you want to call.

DEALER A

- ➔ The phone number programmed in the one-touch dialing memory is dialed out. The programmed name appears on the display.

3. When the call is answered, speak toward the microphone.

- If you do not wish to use the speakerphone feature, lift the handset to start and replace it to finish.

For SFX-110

1. Press [>] (or lift the handset).

26 Jun. '96 12:00

2. Press the one-touch key (1-8) for the party you want to call.

DEALER A

- ➔ The phone number programmed in the one-touch dialing memory is dialed out. The programmed name appears on the display.

3. When the call is answered, lift the handset and talk.

26 Jun. '96 12:00

Speed dial

This feature allows you to place a call without dialing the entire number. Before speed dialing can be used, the phone numbers of the parties must be programmed into memory. A maximum of 20 speed-dialing numbers can be stored in memory. (See pages 64-65 for programming instructions.)

To place a call using speed dialing:

For SFX-210

1. Press [] (or lift the handset).

* SPEAKERPHONE *

2. Press [SPEED DIAL].

S. D : ■

3. Enter the speed-dialing number (01-20) for the number you want to call.

The programmed phone number is dialed out, and the programmed name appears on the display.

DEALER A

4. When the call is answered, speak toward the microphone.

• If you do not wish use the speakerphone feature, lift the handset to start and replace it to finish.

For SFX-110

1. Press [] (or lift the handset).

26 Jun. '96 12:00

2. Press [SPEED DIAL].

S. D : ■

3. Enter the speed-dialing number (01-20) for the number you want to call.

The programmed phone number is dialed out, and the programmed name appears on the display.

DEALER A

4. When the call is answered, lift the handset and talk.

26 Jun. '96 12:00

Dial Bank

The Dial Bank of the SFX-110/210 automatically stores the 20 most frequently called numbers* in memory. You can call up onto the display any number in the Dial Bank, and then dial it out at the touch of a key or transfer it to one-touch or speed dial memory.

To place a call using Dial Bank:

For SFX-210

1. Press [] (or lift the handset).

* SPEAKERPHONE *

2. Press [DIAL BANK].

- A number stored in the Dial Bank appears on the display.

1 1 2 2 3 3

3. Press [DIAL BANK] again to scroll down the number list.

- Numbers are shown starting from the most frequently called one.

1 1 2 2 3 3

4. Press [START] when the desired number is displayed.

- ➔ The SFX-210 dials the number.

* SPEAKERPHONE *

- Numbers dialed using the one-touch or speed dialing will not be stored in the Dial bank.

Editing numbers in the Dial Bank

- Stored numbers in the Dial Bank can be edited to add a name. See pages 68-69.
- When the name of a receiving party appears on your display when you send a fax, the name and the number you dialed will be stored in the Dial Bank.
- A maximum of 16 characters or 32 digits can be stored in each Dial Bank number.

For SFX-110

1. Press [] (or lift the handset).

26 Jun. ' 96 12:00

2. Press [DIAL BANK].

- A number stored in the Dial Bank appears on the display.

1 1 2 2 3 3

3. Press [DIAL BANK] again to scroll down the number list.

- Numbers are shown starting from the most frequently called one.

1 1 2 2 3 3

4. Press [START] when the desired number is displayed.

- ➔ The SFX-110 dials the number.

26 Jun. ' 96 12:00

- Numbers dialed using the one-touch or speed dialing will not be stored in the Dial bank.

Editing numbers in the Dial Bank

- Stored numbers in the Dial Bank can be edited to add a name. See pages 68-69.
- When the name of a receiving party appears on your display when you send a fax, the name and the number you dialed will be stored in the Dial Bank.
- A maximum of 16 characters or 32 digits can be stored in each Dial Bank number.

Original documents

■ Transmittable original size

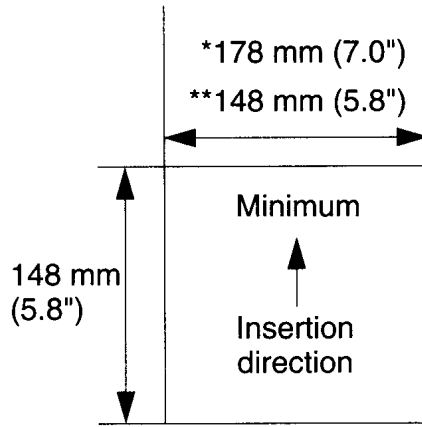
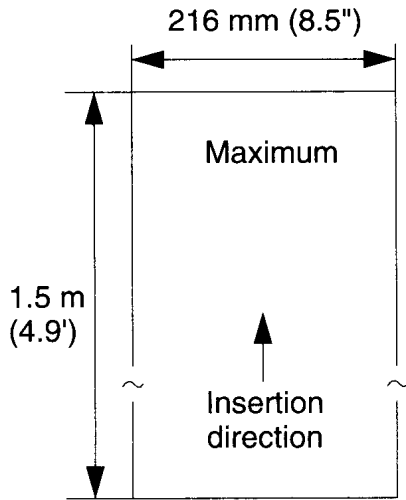

*: multi-page documents

** : single-page document

■ Effective text width

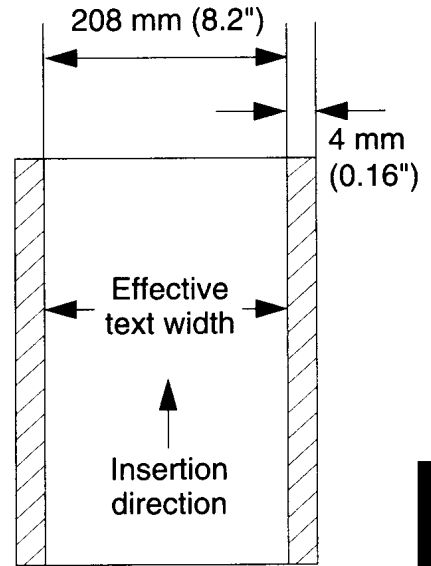

Note: If an original document is larger or smaller than the sizes specified above, it should be reduced or enlarged by a photocopier, and the copy can be used as an original document.

■ Effective thickness

	1 original sheet	multiple sheets
thickness (per sheet)	0.05 - 0.15 mm (0.002" - 0.006")	0.08 - 0.13 mm (0.003" - 0.005")

Notes on the suitability of documents:

- Allow ink and/or glue to dry completely before inserting a document.
- Do not transmit curled or folded documents.
- Make sure that any paper clips, staples or pins have been removed from documents.
- When an original is carbon paper, waxed paper or vinyl-coated paper, use a photocopy of the original.
- Never use documents thicker than 0.15 mm(0.006"), metal sheets or cloth. Use a photocopy instead.

Fax use

Placing original documents



1. Adjust the paper guide to the width of the document.
2. Place the document face down between the guides and gently insert it in the original slot. The document advances slightly.

When transmitting multiple-page documents:

Stack the sheets with the front edges of all sheets aligned straight.

Note:

- Up to 10 sheets can be placed in the original document tray at one time. When transmitting more than 10 sheets, place the first 10 and then add more during transmission.

Contrast/Resolution

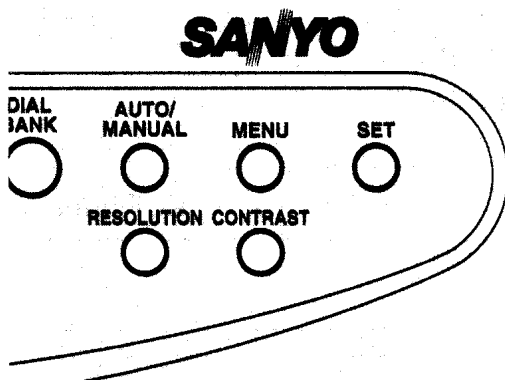

The SFX-110/210 allows you to select different contrast/halftone and resolution modes for fax transmission and copying. Select the most suitable mode for your original document after placing in the original tray. You can also set the SFX-110/210 either to remain in the selected mode until another selection is made, or to return to the default mode after each transmission/copying. Use the feature switches No. 27 and 28 to switch between **Not return** and **Return home** modes.

The initial factory setting is in the **Not return** position. (See pages 75-76 and 78.)

1. Place the original document in the original document tray. The first page advances slightly, and the display changes to:

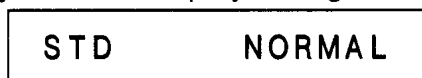

This indicates that the unit is currently set to standard resolution (**STD**) and normal contrast (**NORMAL**) mode.

2. Press the [**CONTRAST**] and [**RESOLUTION**] keys 1 to 3 times to select the desired mode.

[CONTRAST]

NORMAL

For normal contrast documents.



LIGHT

For low contrast documents which need to be transmitted or copied darker.



HALFTONE

For transmitting or copying halftone documents. (photographs, for example).

When HALFTONE is selected, the resolution mode is automatically set to FINE.

[RESOLUTION]

STD

For text in standard typefaces.



FINE

For text with fine type and for drawings.



SUPERFINE

For text with very small characters and/or graphics.

The superfine communication mode is possible only with Sanyo fax models with the superfine feature and with non-Sanyo models that have international standard (ITU-T) superfine feature.

Manual transmission

Manual transmission is like placing a call and then sending a fax. When your call is answered by a fax tone, the SFX-110/210 automatically starts fax transmission. Using the speakerphone or handset, you can monitor the line activity.

1. Place the original document face down.

Adjust the paper guide to the width of the document.

STD	NORMAL
-----	--------

2. Select a contrast/resolution mode if necessary. (See page 31.)

STD	NORMAL
-----	--------

3. Lift the handset (or press **speaker** key).

4. Dial the number.

Example: 111-2222

1 1 1 2 2 2 2

You can also use one of the following dialing methods:

One-touch dialing

Press a one-touch key (1 - 8). Programming is required in advance. See pages 62-63.

Speed dialing

Press [**SPEED DIAL**] and enter the speed dial number (01 -20). Programming is required in advance. See pages 64-65.

Dial Bank dialing

Press [**DIAL BANK**] to select a number from the 20 most frequently dialed number list stored in Dial Bank. Then press [**START**]. See page 27-28.

Direct dialing

Dial the number using the number keys.

5. When the SFX-110/210 detects a fax tone sent by the receiving unit, transmission begins automatically.

➔ The name/number of the receiving party appears on your display if their fax machine has a station ID programmed.

A l i s o n M c N a b

6. Replace the handset.

-
- If a person answers your fax call at step 5, you can send a fax by pressing [**START**] after the conversation.
 - Press [**STOP**] to interrupt a transmission or to remove a document set for transmission.
 - If you make a mistake when entering a number, replace the handset and lift it again (or press **speaker** key twice), then enter the correct number.
 - The feature switch No. 54 must be set to the ON (01) position for auto progress transmission to take place at step 5. (This feature is factory-set to ON) See page 78.
If it is set to the OFF (00) position, the [**START**] key has to be pressed to initiate transmission.

Automatic transmission

You can send a fax without using the handset or speaker key. This is called "automatic transmission" since your unit automatically sends a fax signal to the party if you do not use the handset or speaker key.

1. Place the original document face down.
Adjust the paper guide to the width of the document.

STD	NORMAL
-----	--------

2. Select a contrast/resolution mode if necessary. (See page 31.)

STD	NORMAL
-----	--------

3. Dial the number.

Example : 123456

You can use one of the following dialing methods:

One-touch dialing

Press a one-touch key (1 - 8). Programming is required in advance. See pages 62-63.

Speed dialing

Press [**SPEED DIAL**] and enter the speed dial number (01 - 20). Programming is required in advance. See pages 64-65.

Dial Bank dialing

Press [**DIAL BANK**] to select a number from the 20 most frequently dialed number list stored in Dial Bank. Then press [**START**]. See page 27-28.

Direct dialing

Dial the number using the number keys and press [**START**].

1 2 3 4 5 6

Fax use

4. When the line is connected, transmission begins automatically.
➔ The name/number of the receiving party appears on your display if their fax machine has a station ID programmed.

A l i s o n M c N a b

- If the line is busy or there is no answer, the unit automatically redials the number 2 times. (See page 34.)
- Press [**STOP**] to interrupt a transmission or to remove a document set for transmission.
- If you make a mistake when dialing a number, press [**STOP**], then enter the correct number.

Redial

Automatic redial

When an automatic fax transmission attempt fails due to a busy phone line (no answer), the SFX-110/210 automatically redials the number 2 more times.

Display shows:

WAITING REDIAL

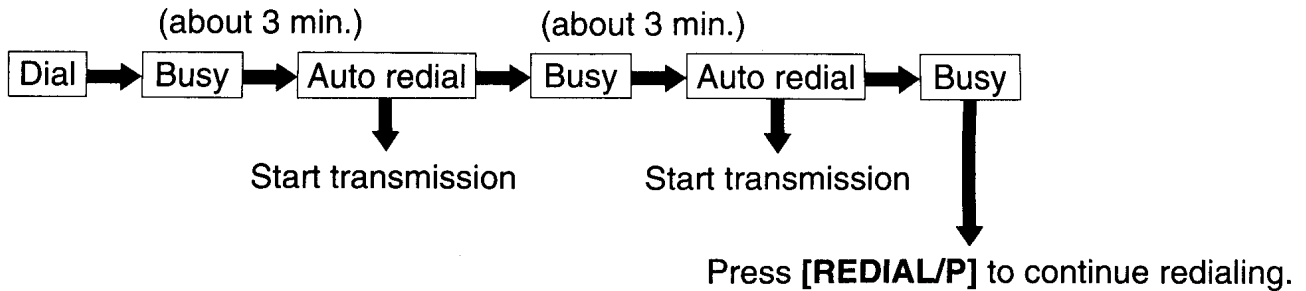

- If the document has been removed, automatic redialing is canceled.
- The SFX-110/210 is set to redial a number twice (three times for a number dialed using the timer transmission) at three minute intervals. These settings can be changed using the features switches No. 05 and No. 06. (See pages 75-77.)

Manual redial

1. Press **[REDIAL/P]**.
The number is redialed.

Overseas transmission

When you transmit a fax to an overseas party, poor telephone line connection may cause a transmission error to occur. The overseas transmission feature may be used to reduce communication errors with overseas parties.

1. Place the original document face down.
Adjust the paper guide to the width of the document.

STD NORMAL

2. Select a contrast/resolution mode if necessary. (See page 31.)

STD NORMAL

3. Press [**SPEED DIAL**].

S. D : ■

4. Press [#].
➔ A beep sounds.

4800BPS SET

5. Enter the overseas access code.
Example: 011

011

6. Press [**REDIAL/P**] to enter a 4-second pause.

011;

7. Dial the country code and fax number.
Example: 4911222333

011;49111222333

8. Press [**START**].
➔ When the line is connected, transmission begins automatically.





011;49111222333

Fax use

-
- The overseas transmission feature may also be used for local communications when a transmission error occurs.

Timer transmission

The SFX-110/210 can be programmed for delayed fax transmission. The delayed start time can be set up to 24 hours in advance. A maximum of 10 pages can be sent to one destination using the timer feature.

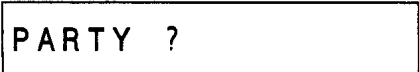
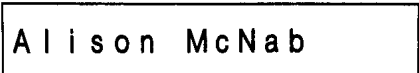
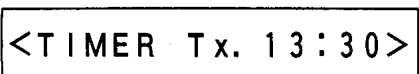
1. Place the original document face down.
Adjust the paper guide to the width of the document.

2. Select a contrast/resolution mode if necessary. (See page 31.)

3. Press **[MENU]** 3 times.

4. Press **[SET]**.

5. Enter a delayed start time using the number keys.
(The start time must be entered using the 24-hour system.)
Example: 13:30

6. Press **[SET]**.

7. Enter the fax number.
You can use one-touch dial, speed dial or number keys.
Example: One-touch dial 1.

8. Press **[SET]**.
➔ A beep sounds.

-
- Press **[STOP]** to interrupt a transmission or to remove a document set for transmission.
 - If you make a mistake when entering start time at step 5, press **[DELETE]** then enter the correct time.
 - If you make a mistake when entering the number at step 7, press **[STOP]**, then enter the correct number.

Canceling timer transmission

To cancel a programmed timer transmission:

1. Press **[MENU]** 3 times.
2. Press **[SET]**.
 - ➔ The display shows "CANCEL ?".
3. Press **[SET]**.
 - ➔ A beep sounds.
 - To remove inserted documents, press **[STOP]**.

Changing programmed timer transmission

1. Press **[MENU]** 3 times.
2. Press **[SET]**.
 - ➔ The display shows "CANCEL ?".
3. Press **[MENU]** to select "CHANGE ?".
 - ➔ The display shows "CHANGE ?"
4. Press **[SET]**.
5. Press **[DELETE]** to clear the wrong start time.
6. Enter a correct delayed start time.
7. Press **[SET]**.
8. Press **[STOP]** to delete the wrong number.
9. Enter a correct fax number.
10. Press **[SET]**.
 - ➔ A beep sounds.

Timer transmission report

Using the feature switch No.32, you can program the SFX-110/210 to automatically issue a timer transmission report (See page 75-76 and 78):

00	OFF (No report issued)
01	ON (after each timer transmission)
02	ON (when an error occurs)

- The switch is initially factory-set to the OFF (no report) position.
- If a fax number is busy when a timer transmission is attempted, the number is automatically redialed three times.

The number of redials can be changed using the feature switch No. 05. (See pages 75-77.)

Reception

Selecting the reception modes

The SFX-110/210 provides three reception modes: AUTO, MANUAL and ANSWER.

The **[AUTO/MANUAL]** key switches between AUTO and MANUAL modes. The AUTO lamp lights when AUTO mode is selected.

To set to ANSWER mode, press the **[ANSWER]** key. The ANSWER lamp lights. Once ANSWER mode is turned on, this overrides the setting of the AUTO/MANUAL key.

Press **[ANSWER]** again to turn off the ANSWER mode. The unit returns to the mode previously selected.

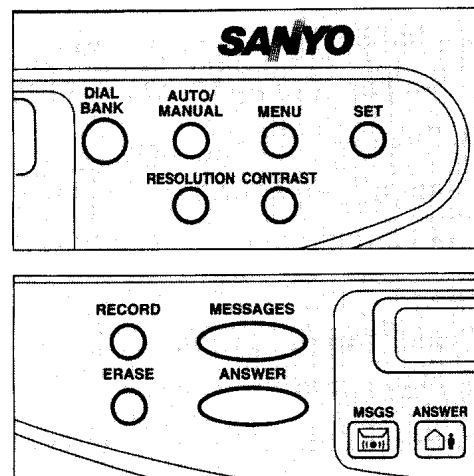

AUTO mode

Receiving faxes is automatic in AUTO mode. No operation is required on the SFX-110/210 or an extension telephone connected to the SFX-110/210 through the Break-in Adaptor to receive faxes.

Select this mode when you have a dedicated fax line. Ring delay resetting may be desirable.

With the user-selectable ring delay feature, the AUTO mode is suitable for single line users who receive both fax and voice calls on the same number.

Ring delay in AUTO mode

When the unit is in the AUTO mode, the SFX-110/210 rings 3 times* before it connects to the line. And, if the call is not answered, it issues 7 simulated rings* after the line is connected.

*Both first and second sets of ring counts are user-selectable.

See the next 2 pages for more details on the AUTO reception mode.

MANUAL mode

Select this mode if you use the SFX-110/210 mainly for fax transmission, and wish to receive faxes with your control only. Incoming faxes can be received only after you answer the call.

ANSWER mode

Select this mode when you want the SFX-110/210 to automatically receive both fax and voice messages while you are away.

For SFX-210

All voice calls are directed to the built-in telephone answering system. See page 42 for more details.

For SFX-110

All voice calls are directed to the connected telephone answering machine. See page 43 for more details.

Auto reception mode

AUTO reception operation sequence

1. When a call arrives, the SFX-110/210 connects to the line after it rings 3 times*.
(*User-selectable ring delay. See **IMPORTANT** below.)

➔ From this moment, callers will be charged for the phone call.

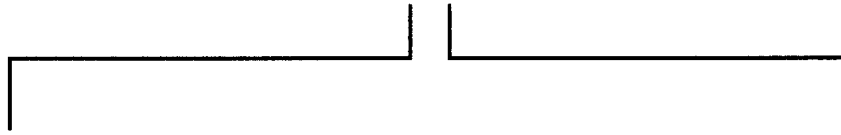

2A. The call is an automatic fax transmission:

The SFX-110/210 detects incoming fax signals and begins receiving fax.

**** RECEIVING ****

2B. The call is a voice call or manual fax transmission:

The SFX-110/210 does not switch to fax reception mode immediately, and issues 7 simulated rings**.

If the call is still unanswered, fax reception starts automatically after the second set of rings.

(**User-selectable. See **IMPORTANT** below.)

Fax use

IMPORTANT

When you select AUTO mode, you may wish to change the ring delay settings to best suit your fax and telephone use — whether you have a dedicated fax number or you use a single line for both fax and voice calls. Use the feature switches No.07 and No.09.

* **Feature switch No. 07** (first set of rings) can be set to a short ring or regular rings (1 to 11 rings). Default setting is 3 rings.

** **Feature switch No. 09** (second set of rings) can be set to no rings or 3-11 rings. Default setting is 7 rings.

See pages 75-77 for feature switch resetting procedures.

FAX/TEL use

The default ring count settings for AUTO reception mode are designed to suit users who have a single line for both fax and telephone use, and wish to answer all voice calls by themselves.

FAX only use

If you have a dedicated fax line, it is recommended to change the first ring counts (Feature switch No. 07) to **one short ring** (code# 00), and the second ring counts (Feature switch No. 09) to the **OFF** (code# 00) position.

What to do if you answer a fax call before the SFX-110/210 connect to the line.

- If you use the handset of SFX-110/210, fax reception starts automatically. Replace the handset.
- If you pick up the call from an extension telephone connected to the SFX-110/210 through the Break-in Adaptor, press [3] and then [3] firmly on the extension phone to activate fax reception.

See **Remote reception** on pages 44.

Remote reception activation number can be changed to any 2-digit number from 10 to 99.

(The default setting of the remote reception number is set to [3], [3] by feature switch No. 08)

- Pressing the **[START]** key on the SFX-110/210 will always initiate fax reception.

Manual reception mode

When set in MANUAL mode, the SFX-110/210 rings just like a telephone. When a call arrives, the unit and an extension telephone connected ring until you answer the call using one of them. Incoming faxes can be received with your initiation only.

1. Lift the handset when the telephone rings.

2A. The call is a voice call:

Talk.

3A. If caller wants to send a fax after the conversation is complete, press **[START]**. Your caller can send a fax after hearing a fax tone.

2B. The call is an incoming fax :

You hear an incoming fax tone. The SFX-110/210 receives the incoming fax automatically*.

*You may need to press the **[START]** key to initiate fax reception, if you have a noisy line or if the feature switch No. 54 has been turned OFF(00). The switch is initially factory-set to ON(01).

3B. Replace the handset.

**** RECEIVING ****

4B. When reception is complete, the display shows date and time.

SFX-210: 26 Jun. 12:00 00

SFX-110: 26 Jun. '96 12:00

If you answer a fax call on an extension phone:

- If you pick up the call from an extension phone connected to the SFX-110/210 through the Break-in Adaptor, press **[3]** twice firmly on the extension phone to activate fax reception. See **Remote reception** on pages 44.

Note: For SFX-210, you may use speaker key [🔊] at step 1, and if the call is a voice call, talk toward to the microphone.

Fax Use

Answer reception mode

For SFX-210

When set in ANSWER mode, the SFX-210 (and an extension telephone connected through the Break-in Adaptor) rings 3 times* or according to the Toll Saver setting of the built-in answering system if you have turned on this feature. (See page 57-58 for Toll Saver ring count setting.) Then, if the call is not answered, the line connects and the built-in answering system sends your greeting to the caller.

When a call arrives:

1. The SFX-210 (and an extension telephone connected) rings 3 times*.

* The number of rings is user-selectable. Use the feature switch No. 07 to change the number. See pages 75-77.

2. The line connects and the built-in answering system answers the call with your greeting.

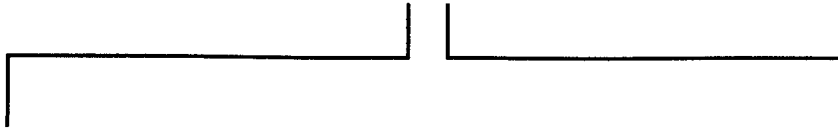

3A. The call is an Incoming fax (by automatic transmission):

The SFX-210 automatically receives the fax after your greeting is played.

**** RECEIVING ****

3B. The call is a phone call (or a manual fax call):

Your answering system starts recording after the beep following your greeting. Callers can now leave a message.

Advise your callers, in your greeting, that a fax can be received during or after the greeting.

Example: If you are sending a fax, start transmission now. Or please leave a voice message after the tone.

- ➔ If no voice is heard for 6 seconds after the beep following your greeting, the SFX-210 automatically switches over to the fax receiving mode and sends a fax tone to the caller.
- ➔ You can hear callers leaving a message for you. To speak to the caller, lift the handset or press [] key. Recording stops.

Note:

- When there is no recording time (less than 30 seconds), incoming call does not switch to Answer mode. The SFX-210 works as AUTO reception mode. (See page 39.)
- When the recording time becomes less than 30 seconds during recording the message, the SFX-210 issues 5 short beeps to the caller and disconnects the line automatically.

For SFX-110

Use this mode if you want to receive both phone messages and faxes while you are away. (Connect an answering machine to the SFX-110 through the Break-in Adaptor.)

When a call arrives:

1. The SFX-110 (and an extension telephone connected) rings according to the ring delay setting of your answering machine.
2. The line connects and your answering machine answers the call with your greeting.

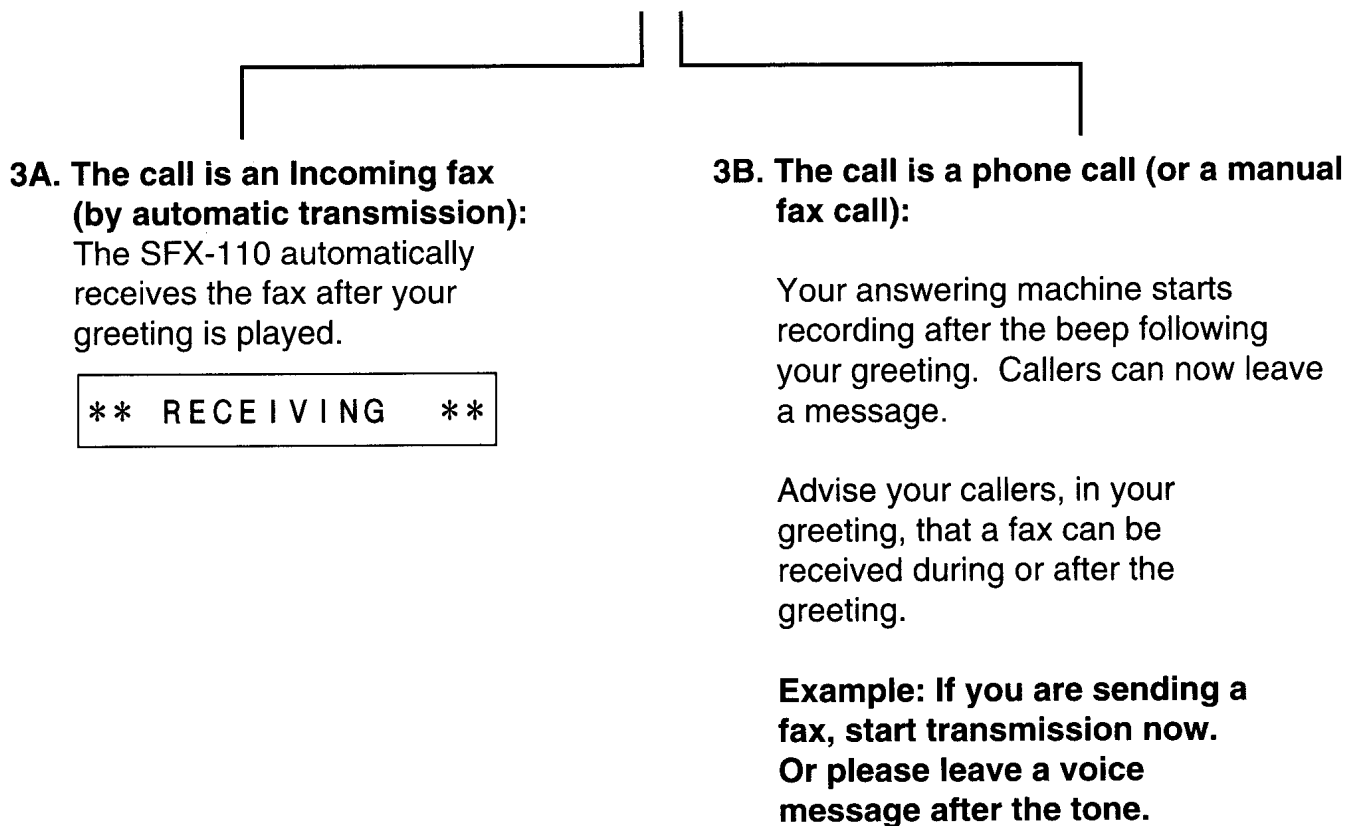
**Fax use**

- ➔ If no voice is heard for 6 seconds after the beep following your greeting, the SFX-110 automatically switches over to the fax receiving mode and sends a fax tone to the caller.
- ➔ The answering machine must be set to answer a call within 4 rings.
- ➔ When the SFX-110 is set to ANSWER mode, there may be some difficulties in remote message retrieval operation of the connected answering machine. If you need to access the answering machine by remote, the SFX-110 must be set to MANUAL mode.

Remote reception

The remote reception feature allows a fax reception after a telephone call is answered by an extension telephone connected to the SFX-110/210 through the Break-in Adaptor.

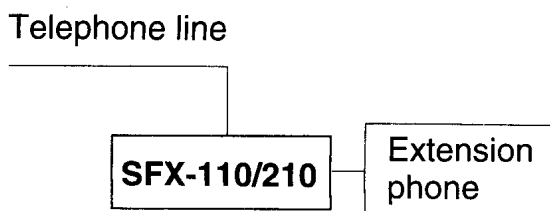

The feature switch No. 08 (Remote receiving) must be set to ON. (The initial factory setting is ON).

1. When an incoming call is received, lift the handset of the extension phone.
2. Talk if it is a voice call. If it is a fax, then:
3. Enter **[3]** twice on the extension phone to activate a fax reception.
4. Replace the handset.

-
- **Remote reception activation number** is initially set to 33.
To change this number, use the feature switch No. 08. (See pages 75-77.)

Notes:

- For SFX-110, remote reception does not work when the reception mode is set to ANSWER mode.
- Remote reception may not function properly on certain telephones.

Polling reception

The polling reception feature allows you to call another party and instruct the other party's machine to transmit a document to your number. (The other party's fax machine must be set to polling transmission mode.)

The cost of the call is billed to the receiving party.

1. Press **[MENU]** once.

1 : POLLING Rx. ?

2. Press **[SET]**.

PARTY ?

3. Dial the other party's fax number.

Example: 111-2222

You can use one-touch, speed dial or number keys.

1 1 1 2 2 2 2 ■

4. Press **[SET]**.

➔ The unit begins dialing.

• When the line is connected, reception begins automatically.

1 1 1 2 2 2 2

Fax use

• Press **[STOP]** to interrupt a reception.

Note:

• The other fax machine must be using international standard (ITU-T) polling.

Selective reception

This feature allows you to restrict reception to certain parties. Using the feature switch No. 26, you can select either ACCEPT mode, REFUSE mode or OFF. (The initial factory-set position is OFF.) See page 78.

Accept

Reception is possible only when the other party's fax number is programmed in the one-touch or speed dial memory of your SFX-110/210.

- If a fax arrives from other numbers than those programmed in the memory of your unit, the SFX-110/210 will disconnect from the line after the display shows RECEIVING.
- If a party's fax machine does not have a station identification feature or the station number has not been programmed in their fax machine, no faxes will be received from this number (even if the number is programmed in your unit.)

Refuse

The SFX-110/210 allows you to create a Refuse list and store up to 20 fax numbers in its memory. The SFX-110/210 will not receive faxes sent from the parties whose numbers are programmed in the Refuse list.

- The Refuse feature checks the last 4 digits of a number.
- When the Refuse mode is selected, the SFX-110/210 will not receive faxes from any party whose unit has no station identification feature or whose station number is not programmed in their unit.

Programming the Refuse list

1. Press [MENU] 4 times.

SFX-210: 4 : SET FAX MODE ?

SFX-110: 4 : SET MODE ?

2. Press [SET].

1 : SET TIME ?

3. Press [MENU] 4 times.

5 : REFUSE LIST ?

4. Press [SET].

1 : SET 2 : DELETE

5. Press [SET].

(01) ■ : SET

6. Press **[MENU]** to select a Refuse list number from 01 to 20.
- The number display scrolls one at a time as you press **[MENU]**.

(01) ■ :SET

7. Enter the last 4 digits of the number you want to refuse.
- Example:**1234

(01) 1234 ■ :SET

8. Press **[SET]**.
- ➔ A beep sounds.
 - To program other numbers, repeat steps 6-8.

(01) 1234 :SET

9. Press **[STOP]** twice to return to stand-by mode.

SFX-210: 26 Jun. 12:00 00

SFX-110: 26 Jun. '96 12:00

Fax use

- If you make a mistake when entering the number, press **[DELETE]** and then re-enter the correct number.
- When a caller whose name is programmed in your Refuse list calls you, the SFX-110/210 rings and you can talk to the caller.
- To turn off selective reception feature, change the feature switch No. 26 setting to OFF.

To change a number programmed in the Refuse list:

1. Operate steps 1-5 above.
2. Press **[MENU]** to select the Refuse list number you want to change.
3. Press **[DELETE]**.
4. Enter the new 4 digits.
5. Press **[SET]**.
 - ➔ A beep sounds.
6. Press **[STOP]** twice.

To delete a number programmed in the Refuse list:

1. Operate steps 1-4 of the programming procedure.
2. Press **[MENU]** to select "2:DELETE".
3. Press **[SET]**.
4. Press **[MENU]** to select the Refuse list number you want to delete.
5. Press **[SET]**.
 - ➔ A beep sounds. Repeat steps 4-5.
6. Press **[STOP]** twice.

Phone reservation

This feature allows you to start a phone conversation after sending or receiving a fax.

To start a phone conversation after sending a fax:

1. Lift the handset during fax transmission.
 - When the fax transmission is completed, a beep sounds at the other side for 7 seconds.
2. When the other party picks up the handset, you hear a beep. Talk to the other party.

To start a phone conversation after receiving a fax:

1. Lift the handset during fax reception.
 - When the reception is completed, a beep sounds at the other side for 14 seconds.
2. When the other party picks up the handset, you hear a beep. Talk to the other party.

-
- If you lift the handset and replace it, phone reservation is canceled.
 - If the other party does not pick up the handset while the beep sounds, the phone line will be disconnected.
 - If the other unit does not have phone reservation function, the phone line will be disconnected.

Phone reservation reception

If the other party initiates phone reservation, a beep sounds and the display shows **PHONE CALLING**. Lift the handset and talk to the calling party.

Diagnostic reports

The codes shown below appear on the activity and timer transmission reports to help you diagnose any problems quickly and accurately.

ERROR CODE	DESCRIPTION
OK:	<ul style="list-style-type: none">• Transmission/reception satisfactory.
10:	<ul style="list-style-type: none">• No response from other party. Contact other party to make sure their machine is ready to receive.• Make sure the telephone line is connected to the LINE jack of the unit.
12:	<ul style="list-style-type: none">• No response to timer transmission.
16:	<ul style="list-style-type: none">• Mechanical error (See page 94).
20:	<ul style="list-style-type: none">• [STOP] key pressed during transmission/reception.
21:	<ul style="list-style-type: none">• Original document jammed. Remove and replace correctly.
23:	<ul style="list-style-type: none">• Recording paper ran out during reception. Replace recording paper.
24:	<ul style="list-style-type: none">• Recording paper jammed during reception. Check the recording paper.
25:	<ul style="list-style-type: none">• Cutter did not work during reception. Contact an authorized Sanyo service center.
27:	<ul style="list-style-type: none">• Timer transmission is canceled or no original inserted for timer transmission.
30:	<ul style="list-style-type: none">• Printing quality poor due to poor telephone line connection. If this code appears frequently, contact an authorized Sanyo service center.
40:	<ul style="list-style-type: none">• Other party's fax machine in abnormal condition (no recording paper, etc.) Contact the other party.
50:	<ul style="list-style-type: none">• Transmission was halted by the other party. (Line was disconnected during transmission/reception.)
60:	<ul style="list-style-type: none">• Communication impossible due to poor telephone line.
71:	<ul style="list-style-type: none">• Communication impossible due to compatibility problems. Contact other party. Make sure the feature switch No. 26 is set to OFF.

Fax use

Digital answering system (only for SFX-210)

The SFX-210 has a built-in digital answering system that records both your greeting and callers' voice messages on an IC chip. The maximum recording time for both is 14 minutes in total.

Recording your greeting

You must record your greeting before you can use the built-in answering system.

1. Press **[RECORD]** for one second.

➔ Two short beeps sound.

RECORDING

2. State your greeting message to the microphone.

- The maximum recording time for greeting is 3 minutes.
- For the best sound quality, speak about 35 to 50 cm away from the microphone. If the location is noisy, come closer to the microphone.

RECORDING

3. Press **[RECORD]** again to finish recording.

➔ The recorded greeting is played back for your confirmation.

PLAYING GREETING

-
- To interrupt recording, press **[STOP]**.
 - If the recording time exceeds 3 minutes, 5 short beeps sound and no recording is made. Restart from step 1.
 - No greeting can be recorded while the fax telephone or the extension telephone connected to the unit is in use.
 - If a call comes in while you are recording, the recording will be canceled.
 - It is helpful to include a statement of the answering telephone number with the exchange name or national number.

Setting the answer mode

1. Press **[ANSWER]** to turn the ANSWER reception mode on.

➔ The ANSWER lamp lights and your greeting plays once.

PLAYING GREETING

- To turn off the ANSWER mode, press **[ANSWER]** again. The ANSWER lamp turns off.
- If the backup battery is exhausted or not installed, the answering system takes about 36 seconds to start functioning properly after the SFX-210 is powered.
- The ANSWER mode overrides AUTO/MANUAL mode setting.

Playing messages (only for SFX-210)

When messages are recorded, the MSGS lamp blinks and the display shows the number of received messages.

26 Jun. 12:00 02



Message counter

To play back messages:

1. Press **[MESSAGES]**.

➔ Messages play back starting from the oldest one.

The display shows recorded date and time of the playing messages.

Sun 10:20 1/02

2. You can skip, repeat or backskip messages.

- To skip the next message, press **[9]**.
- To repeat a message, press **[7]**.
- To return to the previous message, press **[7]** twice.

3. Playback stops once all recorded messages are played.

If you keep messages you have heard, available memory space for new messages will become small. We recommend to erase as many messages as possible once you have played them back. See next page for message erasing options.

- To interrupt message playback, press **[STOP]**.
- When there are no messages recorded, 5 beeps sound when the **[MESSAGES]** key is pressed. The display shows NO MESSAGES!.
- If an incoming call arrives during message playback, playback stops and the SFX-210 rings.
- If the caller does not speak for 6 seconds after the SFX-210 starts recording, the unit automatically switches into fax receiving mode. The call may be counted as a message.
- If the caller hangs up within 3 seconds after the line connects, the call will not be counted.

TAS use

Erasing messages (only for SFX-210)

You can erase a single message at a time or all recorded messages at once. You can also program the system to automatically erase all messages as soon as they have been played once.

All message erase

1. Press **[MESSAGES]** while pressing **[ERASE]**.

ERASE ALL MSGS ?

2. Press **[ERASE]** again.

➔ A beep sounds.

All messages are erased.

ERASED

• To cancel all message erase, press **[STOP]** after step 1.

Individual message erase

1. Press **[ERASE]** while playing the message you want to erase.

ERASE THIS MSG ?

2. Press **[ERASE]** again.

➔ A beep sounds.

The message is erased.

The next message starts playing.

Repeat steps 1-2 to erase other messages.

ERASED

3. Press **[STOP]** to finish erasing.

• If you press **[ERASE]** by accident during playing messages, press **[STOP]** to undo the erase.

Automatic message erase (only for SFX-210)

You can program the SFX-210 to automatically erase each message once it has been played. The initial factory-setting is OFF (no auto erase).

1. Press **[MENU]** 5 times.

5 : SET ANSW MODE ?

2. Press **[SET]**.

1 : PASSWORD ?

3. Press **[MENU]** twice.

3 : AUTO ERASE ?

4. Press **[SET]**.

AUTO ERASE OFF

5. Press **[MENU]** to select ON.
The **[MENU]** switches between ON and OFF.

AUTO ERASE ON

6. Press **[SET]**.
➔ A beep sounds.

4 : TOLL SAVER ?

7. Press **[STOP]** to return to stand-by mode.

26 Jun. 12:00 00

TAS use

-
- The auto erase does not erase any messages that have not been played yet (by skipping or pressing **[STOP]**, for example).
 - If you retrieve messages by remote access using an outside phone, auto erase does not take place.

Remote operation (only for SFX-210)

You can listen to the messages recorded in the built-in answering system from an outside Touch-Tone telephone.

To be accessible by a remote operation, the SFX-210 must be set to the ANSWER mode, and a 4-digit password must have been programmed by you. See next page for password programming.

Basic operation

1. Call your SFX-210 from an outside Touch-Tone phone.
2. Press and hold the [*] key for 2-3 seconds while your greeting is playing.
 - ➔ The greeting stops, and 3 short beeps sound.
3. Enter the 4-digit password.
 - ➔ Two short beeps sound.
 - To program 4-digit password, see next page.
4. Within 10 seconds, enter the remote operation code of the function you want to perform.

Function	Remote operation code
Playing messages	[#]
Single message erase	[#] while the message is playing + [0] + [0]
All messages erase	[0] + [0] after all messages have been played.
Message skip	[9] during playback
Message repeat	[7] during playback
Backward skip	[7] + [7] during playback
Turning off ANSWER mode	[*] + [*] *

* When you press [*] twice, a beep sounds after the ANSWER mode is turned off, and then the line is disconnected.

5. You can enter another remote operation code after hearing 3 short beeps.

• You can change the reception mode from AUTO to ANSWER by remote operation.

- 1) Press [*] while the SFX-210 release the simulated ring (2nd ring).
 - ➔ You hear 3 short beeps.
 - 2) Enter the password.
 - ➔ You hear 3 short beeps.
- The SFX-210 is now set to ANSWER mode.

- If you enter a wrong password or a wrong remote code, 5 short beeps alert you. Then 2 beeps sound and you can re-enter the correct password.
- If you continuously enter 3 wrong password, the line will be disconnected.
- If greeting does not stop after you enter [*], press it again for 2-3 seconds.
- If you take more than 10 seconds to enter a remote operation code, the line will be disconnected.

Password programming (only for SFX-210)

To be accessible by a remote operation, a 4-digit password must have been programmed by you. The default password is "3210".

1. Press **[MENU]** 5 times.

5 : SET ANSW MODE ?

2. Press **[SET]**.

1 : PASSWORD ?

3. Press **[SET]** again.

PASSWORD ? 3 2 1 0

4. Enter your new password.

Example: 4321

PASSWORD ? 4 3 2 1

5. Press **[SET]**.

➔ A beep sounds.

2 : RECORD MODE ?

6. Press **[STOP]** to return to stand-by mode.

26 Jun. 12:00 00

- If you enter a wrong password at step 4, re-enter the correct one.
- To change the password, restart from the first step.

Message recording modes (only for SFX-210)

The built-in answering system allows you to choose from 3 options how it takes callers' messages:

VOX (MAX 3 MIN)

Record as long as caller speaks or up to 3 minutes.
This is the factory-set default.

ANSWER ONLY

Answers callers with your greeting, but does not record any messages.

FIX 30 SEC.

Every caller has 30 seconds only to record a message.
Even if a caller hangs up without leaving a message, the answering system records for 30 seconds.

1. Press **[MENU]** 5 times.

5 : SET ANSW MODE ?

2. Press **[SET]**.

1 : PASSWORD ?

3. Press **[MENU]**.

2 : RECORD MODE ?

4. Press **[SET]**.

VOX (MAX 3 MIN)

5. Press **[MENU]** to select a recording mode.

FIX 30 SEC.

6. Press **[SET]**.

➔ A beep sounds.

3 : AUTO ERASE ?

7. Press **[STOP]** to return to stand-by mode.

26 Jun. 12:00 00

Toll saver setting (only for SFX-210)

The Toll Saver feature can save you long distance phone charges. It allows you to know whether you have messages in the built-in answering system — without connecting to your machine — when you call your SFX-210 away from home for remote message retrieval. When this feature is turned ON, the ring delay count of the SFX-210 changes once the answering system has voice messages.

The Toll Saver feature has been factory-set OFF.

Both ring delay counts (with and without messages) are user-selectable when the feature is turned ON.

1. Press **[MENU]** 5 times.

5 : SET ANSW MODE ?

2. Press **[SET]**.

1 : PASSWORD ?

3. Press **[MENU]** 3 times.

4 : TOLL SAVER ?

4. Press **[SET]**.

TOLL SAVER OFF

5. Press **[MENU]** to select between ON and OFF. Select ON.

TOLL SAVER ON

6. Press **[SET]**

NO MSGS 4 RINGS

7. Enter the number of ring delay count (between 2 and 9) you want when there is no incoming messages recorded.

NO MSGS 5 RINGS

Example: 5

8. Press **[SET]**.

MESSAGES 2 RINGS

TAS use

9. Enter the number of ring delay count (between 0* and 9) you want when there are incoming messages recorded.

MESSAGES **3** RINGS

*When the ring count is set to 0, the unit issues one short ring.

Example: 3

10. Press **[SET]**.

➔ A beep sounds.

5:RESET ANSWER?

11. Press **[STOP]** to return to stand-by mode.

26 Jun. 12:00 00

-
- The "No messages" ring delay counts must be set at least 2 rings greater than the "With messages" ring delay.
 - When the Toll Saver feature is OFF, the SFX-210 rings as programmed by the ring delay feature switch No. 07.

Resetting answering system (only for SFX-210)

The initialization commands allow you to reset various programmed features of the answering system to the factory-set default settings.

- | | |
|-----------------------|--|
| ERASE ALL MSGS | To erase all recorded messages |
| ERASE GREETING | To erase your greeting |
| RESET TO DEFLT | To reset the following features to the factory-set default values: <ul style="list-style-type: none">• Password• Message recording mode• Auto message erase• Toll saver |
| CLEAR ALL | To reset all of the above. |

1. Press **[MENU]** 5 times.

5 : SET ANSW MODE ?

2. Press **[SET]**.

1 : PASSWORD ?

3. Press **[MENU]** 4 times.

5 : RESET ANSWRER ?

4. Press **[SET]**.

CLEAR ALL ?

5. Press **[MENU]** to select the command you want to perform from the choices shown above.

ERASE GREETING ?

6. Press **[SET]**.

RESET TO DEFLT ?

➔ Repeat steps 5 to 6 to perform other commands.

➔ A beep sounds if you select "CLEAR ALL" or "RESET TO DEFLT" at step 5.

7. Press **[STOP]** twice to return to stand-by mode.

26 Jun. 12:00 00

• If you select "CLEAR ALL" or "RESET TO DEFLT" at step 5, press **[STOP]** once to return to stand-by mode.

Entering names

Before programming the dialing memory or your station name, you need to know to enter names using number keys and one-touch keys.

The number keys [2], [4], [5], [6], [8] and [0], the one-touch keys [5], [6] and [8] are used for name programming.

The characters are grouped as shown below:

Group 1	Group 2	Group 3
ABCDE	abcde	12345
FGHIJ	fghij	67890
KLMNO	klmno	. , : ; .
PQRST	pqrst	+ - / & *
UVWXY	uvwxy	# ' " ()
Z	z	< > ! ? =

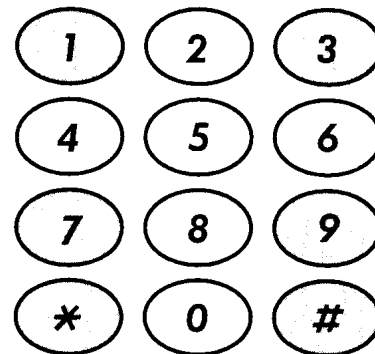

Registration Area Selection Area

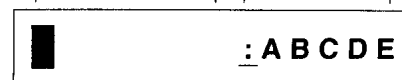

Cursor 1 Cursor 2

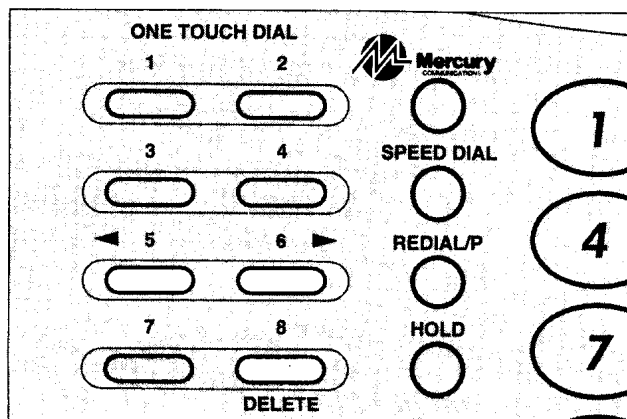

The LCD display is divided into 2 sections: The registration area (left) shows the name being entered, and in the selection area (right), a set of 5 characters appears as you scroll up or down the display. Each area has a separate cursor.

Selecting a character

1. Use number key [5] to select the desired character group.
The first line of the selected group appears each time the number key [5] is pressed.
2. Use number keys [2] or [8] to scroll up or down the display.
3. Use number keys [4] or [6] to move the cursor 2 to select a character.
4. Press [▶] (one-touch key 6) to enter the selected character into registration area. The cursor 1 moves to the right.
5. Repeat steps 1 - 4 to finish writing a name.

- To leave a blank space in the name, press number key [0].
- To backspace the cursor 1, press [◀] (one-touch key 5).
- To advance the cursor 1 to the right, press [▶] (one-touch key 6).
- To erase a character, move the cursor 1 over the character to be erased, and then press the [DELETE] (one-touch key 8).

Example: To enter SFX 210

1. To write S:

Press [8] to scroll up the display and select PQRST.
 Press [6] to move the cursor 2 over the S.
 Press [▶] to enter S.
 The cursor 1 moves to the next position.

S ■ : P Q R S T

2. To write F:

Press [2] to scroll down the display and select FGHIJ.
 The cursor 2 is already on the F.
 Press [▶] to enter F.

S F ■ : F G H I J

3. To write X:

Press [8] to scroll up the display and select UVWXY.
 Press [6] to move the cursor 2 over the X.
 Press [▶] to enter X.

S F X ■ : U V W X Y

4. To leave a space:

Press [0].

S F X ■ : U V W X Y

5. To write 210:

Press [5] to call up the group 3.

S F X ■ : 1 2 3 4 5

Press [6] to select 2, and press [▶].
 Press [6] to select 1, and press [▶].
 Press [8] to scroll up the display and select 67890.
 Press [6] to select 0, and then press [▶].

S F X 2 1 0 ■ : 6 7 8 9 0

- To make a correction, move the cursor 1 over the wrong letter and delete it, and then write the right letter.
- If the procedure is interrupted for more than one minute, the display returns to standby mode. To restart, begin from step 1.

Programming dialing memory

Up to 28 telephone or fax numbers (and corresponding names) can be stored in the memory. The fax/phone numbers stored to each of the 8 one-touch dialing keys (1-8) can be dialed out at the touch of a single key.

An additional 20 numbers can be stored using the speed-dialing numbers (01-20).

One-touch dial number programming

1. Press [MENU] twice.

2 : O. T & S. D SET ?

2. Press [SET].

O. T No. = 1 ?

3. Press one-touch dialing key (1-8).

Example: To program a number in the one-touch key 2, press [one-touch key 2].

O. T No. = 2 ?

4. Press [SET].

█ : ABCDE

5. Enter the party's name (to a maximum of 16 characters).

See pages 60-61 for detailed instructions.

EDWARD █ : ABCDE

6. Press [SET].

█

7. Enter the fax (or telephone) number.

(A maximum of 32 digits can be entered including pauses and hyphens.).

Example: 1-222-3333

1-2 2 2-3 3 3 3 █

8. Press **[SET]**.

➔ A beep sounds.

- To program other one-touch numbers, repeat steps 3-8 above.

O. T No. = **3** ?

9. Press **[STOP]** to finish one-touch number programming.

SFX-210: 26 Jun. 12:00 00

SFX-110: 26 Jun. '96 12:00

- For instructions on printing out a numerical list of programmed names and numbers, see page 67.
- To interrupt programming, press **[STOP]**.
- To enter a hyphen (–), press **[SPEED DIAL]**.
- To enter a 4-second pause between two digits of a number, press **[REDIAL/P]** in the appropriate place. A semicolon (;) in the display indicates a pause.
- If you make a mistake in entering fax/phone number, position the cursor over the digit to be changed using the cursor keys **[▶]** key (one-touch key 6) or **[◀]** key (one-touch key 5), and press **[DELETE]** (one-touch key 8) to delete the digit. Then enter the correct digit.

Speed-dialing number programming

1. Press [MENU] twice.

2:O. T & S. D SET?

2. Press [SET].

O. T No. = 1 ?

3. Enter a speed-dial location number using the number keys.

Example: To store a fax number in the speed-dial location number 10, press [1] and then [0].

S. D No. = 10 ?

4. Press [SET].

█ : ABCDE

5. Enter the party's name (to a maximum of 16 characters).
(See page 60-61 for detailed instructions.)

EDWARD█ : ABCDE

6. Press **[SET]**.

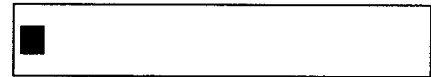

7. Enter the fax (telephone) number to be stored.

A maximum of 32 digits can be entered, including pauses and hyphens.

Example: 1-222-3333

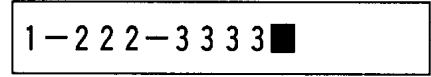

8. Press **[SET]**.

➔ A beep sounds.

Repeat steps 3-8 to program other numbers.

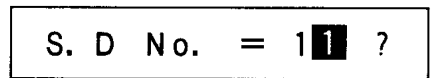

9. Press **[STOP]** to finish speed-dial number programming.

SFX-210: 26 Jun. 12:00 00

SFX-110: 26 Jun. '96 12:00

- For instructions on printing out a list of programmed names and numbers, see page 67.
- To interrupt programming, press **[STOP]**.
- To enter a hyphen (–), press **[SPEED DIAL]**.
- To enter a 4-second pause between two digits of a number, press **[REDIAL/P]** in the appropriate place. A semicolon (;) in the display indicates a pause.
- If you make a mistake in entering fax/phone number, position the cursor over the digit to be changed using the cursor shift keys (**[▶]** and **[◀]**), and press **[DELETE]** key to delete the digit. Then enter the correct digit.

Changing programmed one-touch dialing/speed dialing numbers

1. Press **[MENU]** twice.
2. Press **[SET]**.
3. Press the one-touch dialing key or enter the speed dialing location number of the number you want to change.
Example: To change the number and name programmed in the speed dial number 10, press **[1]** and then **[0]**.
4. Press **[SET]**.
➔ The display shows "CHANGE".
5. Press **[SET]**.
6. Position the cursor over the character to be erased, press **[DELETE]**, and then enter the new name.
(See "Entering names" on pages 60-61.)
7. Press **[SET]**.
8. Position the cursor over the digit to be erased, press **[DELETE]**, and then enter the new number.
9. Press **[SET]**.
➔ A beep sounds.
Repeat steps 3-9 to change other one-touch dialing/speed dialing numbers.
10. Press **[STOP]** to finish.

Canceling programmed one-touch dialing/speed dialing numbers

1. Press **[MENU]** twice.
2. Press **[SET]**.
3. Press the one-touch dialing key or enter the speed dialing number of the number you want to cancel.
Example: To cancel one-touch dialing number 2, press the one-touch key 2.
4. Press **[SET]**.
5. Press **[MENU]** to select "CANCEL".
6. Press **[SET]**.
➔ A beep sounds.
Repeat steps 3-6 to cancel other one-touch dialing/speed dialing numbers.
7. Press **[STOP]** to finish.

Printing a number list

You can print a list of the programmed one-touch dialing and speed-dialing numbers.

Printing one-touch dial/speed dial list

1. Press [MENU] twice.

2:O. T & S. D SET?

2. Press [COPY].

O. T & S. D LIST

3. After the list is printed, press [STOP] to return to standby mode.

SFX-210: 26 Jun. 12:00 00

SFX-110: 26 Jun. '96 12:00

Sample of one-touch dialing/speed dialing number list

*** ONETOUCH, SPEED DIAL LIST ***			
26 Jun. '96 12:00			
	No.	PARTY'S NAME	NUMBER
ONETOUCH DIAL	1	AAA	111222333
	2	BBB	444555666
	3	CCC	777888999
SPEED DIAL	01	DDD	111444666
	02	EEE	333222111
	03	FFF	555777999

Dial Bank editing

You can edit the data stored in the Dial Bank — adding a name or erase a number. You can also transfer Dial Bank data to the one-touch or speed dial memory.

Attaching a name

1. Press **[MENU]** 4 times.

SFX-210: 4 : SET FAX MODE ?

SFX-110: 4 : SET MODE ?

2. Press **[SET]**.

1 : SET TIME ?

3. Press **[MENU]** 5 times.

6 : DIAL BANK ?

4. Press **[SET]**.

➔ The first number in the Dial Bank appears.

1 1 1 2 2 2 2

5. Press **[DIAL BANK]** to select the number you want to add a name to.

1 1 1 3 3 3 3

6. Press **[SET]**.

█ : ABCDE

7. Enter the name (to a maximum of 16 characters).

See pages 60-61 for detailed instructions.

- To transfer this name and number to one-touch dial or speed dial memory, proceed to step 6 of **Transferring to one-touch dial/speed dial** memory on next page.

EDWARD█ : ABCDE

8. Press **[SET]**.

➔ The display shows the next Dial Bank.

- Repeat steps 5-8 to attach a name to other phone numbers of Dial Bank.

1 1 1 4 4 4 4

9. Press **[STOP]** twice to finish editing.

SFX-210: 26 Jun. 12:00 '00

SFX-110: 26 Jun. '96 12:00

- The Dial Bank memory holds 20 numbers you dialed most often. When a new number is added, the Dial Bank bumps out the oldest number with the least frequency. Once a number in the Dial Bank gets a name, the number will not be bumped out until you intentionally erase by erasing operation (see next page).

Transferring to one-touch dial/speed dial memory

Perform steps 1-4 of **Adding a name**, and follow the instructions below:

5. Press [**DIAL BANK**] to select the number to be transferred.

1 1 1 2 2 2 3 3 3

6. Press [**MENU**].

DESTINATION ?

7. Press a one-touch dial key (1-8) or press [**SPEED DIAL**] and enter a 2-digit speed dial number for the destination.

O. T : 3

Example: You select the one-touch key 3.

8. Press [**SET**].

➔ A beep sounds.

- Repeat steps 5-8 to transfer other numbers.

TRANSFERRED

9. Press [**STOP**] twice to finish transferring.

SFX-210: 26 Jun. 12:00 00

SFX-110: 26 Jun. '96 12:00

Erasing a number in dial bank

Perform steps 1-4 of **Adding a name**, and follow the instructions below:

5. Press [**DIAL BANK**] to select the number to be erased.

1 1 1 2 2 2 3 3 3

6. Press [**DELETE**].

DELETE DATA ?

7. Press [**SET**].

➔ A beep sounds.

➔ The display shows the next number stored in the Dial Bank.

- Repeat steps 5-7 to delete other numbers.

DELETED

8. Press [**STOP**] twice to finish erasing.

SFX-210: 26 Jun. 12:00 00

SFX-110: 26 Jun. '96 12:00

Calendar and clock

To set the date and the clock time.

1. Press **[MENU]** 4 times.

SFX-210: 4 : SET FAX MODE ?

SFX-110: 4 : SET MODE ?

2. Press **[SET]**.

1 : SET TIME ?

3. Press **[SET]**.

2 3 04. ' 96 15:00

4. Enter the day, month, year and time using the number keys.

- The time must be entered using 24-hour system.
- The day, month and year should be entered as 2 digits each.

Example: to enter 26 June, 1996, 12:00,
press [2], [6], [0], [6], [9], [6], [1],
[2], [0] and [0].

2 6 06. ' 96 12:00

5. Press **[SET]**.

➔ A beep sounds.

2 : STATION CODE ?

6. Press **[STOP]** to finish calendar/clock setting.

SFX-210: 26 Jun. 12:00 00

SFX-110: 26 Jun. ' 96 12:00

-
- If you make a mistake, move the cursor to the appropriate place, then enter the correct number.

Press **[▶]** to move the cursor right.

Press **[◀]** to move the cursor left.

Header print (Setting your station name and fax number)

Once you have programmed your station name and fax number into the SFX-110/210 memory, this information appears at the top of all faxes you send.

1. Press **[MENU]** 4 times.

SFX-210: 4 : SET FAX MODE ?

SFX-110: 4 : SET MODE ?

2. Press **[SET]**.

1 : SET TIME ?

3. Press **[MENU]**.

2 : STATION CODE ?

4. Press **[SET]**.

█ : ABCDE

5. Enter your station name.

A maximum of 24 characters can be entered.

(See "Entering names" on pages 60-61.)

CHARLES █ : PQRST

6. Press **[SET]**.

█

7. Enter your fax number.

Your fax number can be entered up to 20 digits in length.

Example: 111-2222

1 1 1 - 2 2 2 2 ■

8. Press **[SET]**.

➔ A beep sounds.

3 : FEATURE SW. ?

9. Press **[STOP]** to finish header programming.

SFX-210: 2 6 Jun. 1 2 : 0 0 0 0

SFX-110: 2 6 Jun. ' 9 6 1 2 : 0 0

- To interrupt programming, press **[STOP]** twice.
 - If you make a mistake in entering a number, move the cursor over the wrong digit using the **[▶]** (one-touch key 6) or **[◀]** (one-touch 5) key. Press **[DELETE]** (one-touch key 8) to erase it. Then enter the right digit.
 - To enter a hyphen (–) between two digits, press **[SPEED DIAL]**.
 - To enter a plus sign (+) preceding your fax number, press **[HOLD]**.
 - The header can be printed either outside the original document (in the top margin) or inside the document itself. You can select the desired setting using feature switch No. 20 (See pages 75-77.) Default setting is printing outside of the original.
- NOTE:** If you choose to print the header inside the document, the top of the original document (about 1 cm/0.4") may not be reproduced.

Printing header outside of the original.

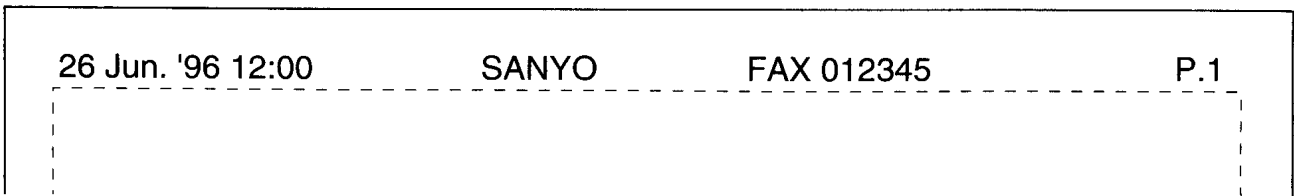

Printing header inside of the original.

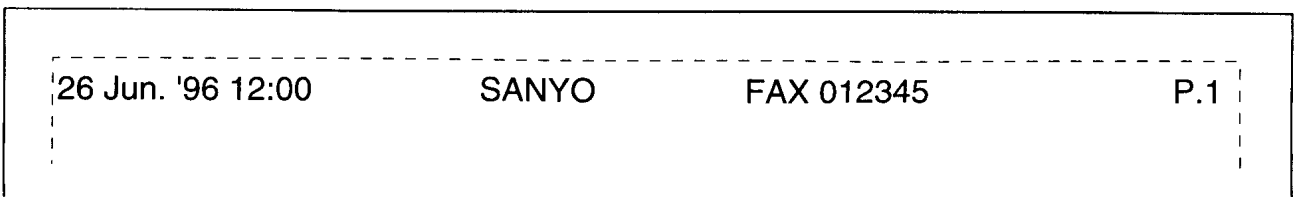

Activity report

You can program the SFX-110/210 to issue an activity report once everyday or after about 20 transmissions/receptions have been performed. It can also be set to issue no activity report.

1. Press **[MENU]** 4 times.

SFX-210: 4 : SET FAX MODE ?

SFX-110: 4 : SET MODE ?

2. Press **[SET]**.

1 : SET TIME ?

3. Press **[MENU]** 3 times.

4 : ACT. REPORT ?

4. Press **[SET]**.

ACT. REPORT ON

5. Press **[MENU]** to select ON or OFF.

- If you choose OFF, proceed to step 8.

Example: ON

ACT. REPORT ON

6. Press **[SET]**.

PRINT TIME : ■

7. Enter the desired issue time using the number keys.

- The time must be entered using 24-hour system.

Example: 16:00

PRINT TIME 16:00

8. Press **[SET]**.

- ➔ A beep sounds.

5 : REFUSE LIST ?

9. Press **[STOP]** to return to standby mode.

SFX-210: 26 Jun. 12:00 00

SFX-110: 26 Jun. '96 12:00

- If you make a mistake when entering the issue time, press **[DELETE]** to clear the incorrect time, and then enter the correct time.
- If the issuing time is not entered at step 7, an activity report is printed automatically when the number of activities (transmission and reception) reaches about 20.
- The initial factory setting is ON with no issue time set.
- If your activities have not been performed, an activity report is not issued at setting time.

Sample of activity report

*** ACTIVITY REPORT ***						
26 Jun. '96 12:00						
					TRNS. TOTAL PAGE 000003	
					RECV. TOTAL PAGE 000002	
TRNS.						
No.	DATE	START	TIME	PARTNER	PAGE	RESULT ERROR CODE
1	26 Jun.	9:00	1'23	AAA	2	OK
2	26 Jun.	10:00	0'45	BBB	1	OK
RECV.						
No.	DATE	START	TIME	PARTNER	PAGE	RESULT ERROR CODE
1	26 Jun.	9:30	1'02	CCC	1	OK
2	26 Jun.	10:30	0'38	DDD	1	OK

Feature switches

The various feature switches on the SFX-110/210 were factory-preset to standard (default) settings. To provide you with more choices, the SFX-110/210 allows you to change these feature switch settings.

The feature switches and their functions are listed on pages 77-78.

To change feature switch settings:

1. Press **[MENU]** 4 times.

SFX-210: 4 : SET FAX MODE ?

SFX-110: 4 : SET MODE ?

2. Press **[SET]**.

1 : SET TIME ?

3. Press **[MENU]** twice.

3 : FEATURE SW. ?

4. Press **[SET]**.

(0 0) DIAL MODE

5. Enter the number of the switch you want to change.

Example: To change the key sound, press **[1]** and **[7]** to select feature switch No. 17.

(1 7) KEY SOUND

6. Press **[SET]**.

HIGH (0 2)

7. Enter the code of your choice.
(See pages 77-78 for available codes.)
Example: To change the key sound
to low, enter [0] and [1].

LOW (01)

8. Press [SET].
Repeat steps 5-8 to make additional
changes (as required).

(20) HEADER PRINT

9. Press [STOP] twice to finish feature
switch programming.

SFX-210: 26 Jun. 12:00 00

SFX-110: 26 Jun. '96 12:00

10. Print a feature switch list (see page 79)
for your confirmation.

• To interrupt the feature switch setting procedure, press [STOP] twice.

Feature switch list

Switch No.	Switch description	Code No.	Code description	Factory setting
00	Dial mode	00	TONE	01
		01	PULSE (10 PPS)	
05	Number of redial attempts after timer transmission attempt. (3 to 4-minute intervals)	00	OFF(No redial)	03
		01	once	
		02	twice	
		03	3 times	
06	Number of automatic redial attempts for regular fax transmission after busy signal is detected using manual, one-touch or speed dialing. (2-3 minutes intervals)	00	OFF(No redial)	02
		01	once	
		02	twice	
		03	3 times	
07	Ring delay Number of rings the unit issues before connecting to the line when the unit is set to the AUTO mode.	00	One short ring	03
		01	1 ring	
		02	2 rings	
		03	3 rings	
		11	11 rings	
08	Remote reception activation number	00	OFF	33
		10 to 99	ON(Select a 2-digit number of your choice)	
09	The simulated ring count that the SFX-110/210 issues after connecting to the line during the AUTO reception mode, but before switching to fax reception mode for an incoming manual fax (or voice call).	00	OFF(No rings/No auto switching)	03
		01	3 rings(Auto switching)	
		02	5 rings(Auto switching)	
		03	7 rings(Auto switching)	
		04	9 rings(Auto switching)	
		05	11 rings(Auto switching)	
10	Music-on-hold	00	OFF(No music)	01
		01	ON (Green sleeves)	
17	Key operation beeps	00	OFF	02
		01	LOW	
		02	HIGH	
20	Header print Determines whether your station name, fax number and date/time are printed on the header.	00	OFF	01
		01	ON (Printing outside of original)	
		02	ON (Printing inside of original)	

Switch No.	Switch description	Code No.	Code description	Factory setting
26	Selective reception Determines whether reception is controlled by your ACCEPT or REFUSE list.	00	OFF	00
		01	ACCEPT	
		02	REFUSE	
27	Home position of the resolution mode	00	STD	03
		01	FINE	
		02	SUPER FINE	
		03	Not return	
28	Home position of the contrast mode	00	NORMAL	03
		01	LIGHT	
		02	HALFTONE	
		03	Not return	
32	Timer transmission report	00	OFF (No report)	00
		01	ON (after each timer transmission)	
		02	ON (when an error occurs)	
36	Halftone quality (relative to transmission speed)	00	Faster transmission	01
		01	Better halftone quality at slower speed	
54	Auto progress transmission/reception	00	OFF (need to press [START] key for manual transmission/reception)	01
		01	ON (no need to press [START] key for manual transmission/reception)	

Printing a feature switch list

You can print a list of all feature switches and their current settings.

1. Press **[MENU]** 4 times.

SFX-210: 4 : SET FAX MODE ?

SFX-110: 4 : SET MODE ?

2. Press **[SET]**.

1 : SET TIME ?

3. Press **[MENU]** twice.

3 : FEATURE SW. ?

4. Press **[COPY]**.

FEATURE SW. LIST

5. Press **[STOP]** after printing to return to standby mode

SFX-210: 26 Jun. 12:00 00

SFX-110: 26 Jun. '96 12:00

Sample of the feature switch list

```

* * * FEATURE SW. LIST * * *
26 Jun. '96 12:00

No. SWITCH NAME SET CODE INITIAL SET
[00] DIAL MODE (01) 10PPS (01) 10PPS
[05] TIMER REDIAL (03) 3 TIMES (03) 3 TIMES
[06] AUTO REDIAL (02) 2 TIMES (02) 2 TIMES
[07] No. OF RINGS (03) 3 TIMES (03) 3 TIMES
[08] REMOTE Rx. (33) 33 (33) 33
[09] F/T SW. OVER (03) ON: 7 TIMES (03) ON: 7 TIMES
[10] MELODY (01) GREENSLEEVES (01) GREENSLEEVES
[17] KEY SOUND (02) HIGH (02) HIGH
[20] HEADER PRINT (01) ON:OUTSIDE (01) ON:OUTSIDE
[26] SELECTIVE Rx (00) OFF (00) OFF
[27] RESOLUTION (03) NOT RETURN (03) NOT RETURN
[28] CONTRAST (03) NOT RETURN (03) NOT RETURN
[32] TIMER REPORT (00) OFF (00) OFF
[36] HALFTONE (01) HIGH QUALITY (01) HIGH QUALITY
[54] AUTO PROG. (01) ON (01) ON
    
```

Mercury Residential Service

There are two methods of access to the Mercury Residential Service:

- Mercury PIN Code Service
- Mercury Residential 132 Service

The charges for both methods of access are the same, with the only difference being the way you access the Mercury network.

Note:

- To check if Mercury is available in your area, and which is the suitable access method for you, telephone Mercury Customer Assistance on Free Call 0500 500 194 (24 hours).

After checking with Mercury, use the application form enclosed with the SFX-110/210 to apply for Mercury service. You can still make calls over the BT network, whether you subscribe to Mercury or not.

Cost Center Codes

The Mercury Cost Center Code option lets you allocate each Mercury call you make to an account or job number. You key in a two-or three-digit code before dialing the telephone number when you make a call via Mercury. This code appears on your bill, so that you can analyze your telephone costs.

The Cost Center Codes option is available with both Mercury PIN Code Service and Mercury Residential 132 Service; to order it, fill in the form enclosed with the SFX-110/210.

If you need more advice on Cost Center Codes or other billing options, telephone Mercury Customer Assistance on Free Call 0500 500 194.

Programming your Mercury key for Mercury PIN Code Service

When you have signed up for Mercury PIN Code Service, Mercury will send you a PIN code. This will arrive in two separate parts, for extra security. Like a bank PIN code, you should keep it secret, so that no-one can use it for making calls on your Mercury account. You need to program your Mercury key with the Mercury access code (131) and your PIN code as follows:

1. Press **[MENU]** 4 times.

SFX-210: 4 : SET FAX MODE ?

SFX-110: 4 : SET MODE ?

2. Press **[SET]**.

1 : SET TIME ?

3. Press **[MENU]** 6 times.

7 : MERCURY SET ?

4. Press **[SET]**.

SET ?

5. Press **[SET]**.

ACCESS CODE=132

6. Press **[MENU]** to select the Mercury access code "131".

ACCESS CODE=131

7. Press **[SET]**.

TIME DELAY=04sec

Mercury resi-
dential service

-
8. Enter the appropriate time delay between 2 and 12-second using number keys.
Example: 6-second

TIME DELAY=0**6**sec

9. Press [SET].

■

10. Enter the PIN code maximum 10-digit using number keys.
Example: 1234567890

1 2 3 4 5 6 7 8 9 **0**

11. Press [SET].
➔ A beep sounds.

1:SET TIME ?

12. Press [STOP] to return to standby mode.

SFX-210: 26 Jun. 12:00 00

SFX-110: 26 Jun. '96 12:00

-
- To interrupt programming, press [STOP] twice.
 - If you make a mistake in entering PIN code, move the cursor over the digit to be changed using the [▶] key or [◀] key, and press [DELETE] key to delete the digit. Then enter the correct digit.
 - PIN code and all subsequent dial numbers will be tone dialed automatically.

Making a test call (Mercury PIN Code Service)

1. Press **speaker** key (or lift the handset).

SFX-210: * SPEAKERPHONE *

SFX-110: 26 Jun. '96 12:00

2. Press [**Mercury**].

MERCURY CALL

3. Wait for a few seconds until the display shows as right.

M

4. If you are using Cost Centers, key in a valid code.

5. Dial 1500. This call is free of charge. During connection you may hear a high-pitched tone (the Mercury Dial Tone). After a few seconds, you should hear a recorded message welcoming you to the Mercury network.

M1500

-
- If your test call does not work after a couple of attempts, clear the Mercury key as described next page, then reprogram it and start again. (See page 81-82.)
If you still have problems, repeat the sequence for programming the Mercury key, this time entering the lengthened time delay at step 8.
If this does not work, telephone Mercury Customer Assistance (Fault Reporting) on Free Call 0500 500 193 for advice.

Clearing the Mercury key (Mercury PIN Code Service)

If you ever send your SFX-110/210 for repair, or need to reprogram, make sure that you clear your Mercury PIN code from the Mercury key so that no-one can discover it and make calls on your Mercury account. When you get your SFX-110/210 back, you will need to reprogram the Mercury key.

1. Press **[MENU]** 4 times.

SFX-210: 4 : SET FAX MODE ?

SFX-110: 4 : SET MODE ?

2. Press **[SET]**.

1 : SET TIME ?

3. Press **[MENU]** 6 times.

7 : MERCURY SET ?

4. Press **[SET]**.

SET ?

5. Press **[MENU]** to select "INITIAL".

INITIAL ?

6. Press **[SET]**.

➔ A beep sounds.

1 : SET TIME ?

7. Press **[STOP]** to return to standby mode.

SFX-210: 26 Jun. 12:00 00

SFX-110: 26 Jun. '96 12:00

• To interrupt programming, press **[STOP]** twice.

Programming your Mercury key for Residential 132

1. Press **[MENU]** 4 times.

SFX-210: 4 : SET FAX MODE ?

SFX-110: 4 : SET MODE ?

2. Press **[SET]**.

1 : SET TIME ?

3. Press **[MENU]** 6 times.

7 : MERCURY SET ?

4. Press **[SET]**.

SET ?

5. Press **[SET]**.

Confirm the display shows
"access code 132".

ACCESS CODE=132

6. Press **[SET]**.

➔ A beep sounds.

1 : SET TIME ?

7. Press **[STOP]** to return to standby mode.

SFX-210: 26 Jun. 12:00 00

SFX-110: 26 Jun. '96 12:00

Mercury resi-
dential service

• To interrupt programming, press **[STOP]** twice.

Making a test call (Mercury Residential 132)

1. Press **speaker** key (or lift the handset).

SFX-210: * SPEAKERPHONE *

SFX-110: 26 Jun. '96 12:00

2. Press **[Mercury]**.

MERCURY CALL

3. Wait for a few seconds until the display shows as right.

M

4. Dial 132. This call is free of charge.
During connection, you may hear a high-pitched tone (the Mercury Dial Tone).
After a few seconds, you should hear a recorded message welcoming you to the Mercury network.

M132

-
- If your test call does not work after a couple of attempts, telephone Mercury Customer Assistance (Fault Reporting) on Free Call 0500 500 193 (24 hours).

Programming Mercury key to one-touch and speed dial memory

The **[Mercury]** key can be programmed to one-touch and speed dial memory.

Before this program, make sure your Mercury key has been programmed for either PIN code or 132 service.

Follow the programming procedure of One-touch (see page 62-63) or Speed dial memory (see page 64-65).

At step 7, entering fax (telephone) number to be stored:

1. Press **[Mercury]**.

M

2. Enter the fax (telephone) number to be stored.

Example: 12223333

M 1 2 2 2 3 3 3 3

3. Continue the procedure of one-touch or speed dial memory programming from step 8.

-
- When programming the access number to PSTN, enter the access number and press **[REDIAL/P]**, then follow the procedure 1 to 3 above.

Making calls via Mercury

For SFX-210

Making a phone call via Mercury

1. Press [] (**speaker** key).

➔  lamp lights.

* SPEAKERPHONE *

2. Press [**Mercury**].

MERCURY CALL

3. Wait for a few seconds until the display shows as right.

M

4. If you are using Cost Centers, key in your chosen code.

5. Dial the number you want to call.
Example: 111222333

M111222333

6. When the call is answered, speak towards the microphone.

- For the best sound quality, speak about 35 to 50 cm away from the microphone.

If the location is noisy, come closer to the microphone.

7. Press [] when the conversation is completed.

- If you do not wish to use the speakerphone feature, lift the handset to start and replace it to finish.
- If you use the [**REDIAL/P**] key to make a repeat call, the SFX-210 will automatically redial the Mercury access digits and the dialed number.
- When [**Mercury**] key is pressed at a dialing, the one-touch and speed dial are not available. Use the number keys for entering the phone numbers.

For SFX-110

Making a phone call via Mercury

1. Press [] (speaker key).

26 Jun. ' 96 12:00

2. Press [Mercury].

MERCURY CALL

3. Wait for a few seconds until the display shows as right.

M

4. If you are using Cost Centers, key in your chosen code.

5. Dial the number you want to call.
Example: 111222333

M111222333

6. When the call is answered, lift the handset and talk.

- If you use the [REDIAL/P] key to make a repeat call, the SFX-110 will automatically redial the Mercury access digits and the dialed number.
- When [Mercury] key is pressed at a dialing, the one-touch and speed dial are not available. Use the number keys for entering the phone numbers.

Making a phone call on a PABX

When the SFX-110/210 is connected to PABX extension line, follow these steps below.

1. Press the outside line access number. (usually 9)

9

2. Press [**REDIAL/P**] to enter a pause.

9 ;

3. Press [**Mercury**].

MERCURY CALL

4. Wait for a few seconds until the display shows as right.

9 ; M

5. Dial the number you want to call.
Example: 111222333

9 ; M 1 1 1 2 2 2 3 3 3

Transmission via Mercury

1. Place the original document.

STD	NORMAL
-----	--------

2. Select a contrast/resolution mode if necessary. (See page 31.)

STD	NORMAL
-----	--------

3. Press **[Mercury]**.

4. If you are using Cost Centers, key in a valid code.

5. Dial the number you want to fax to.
Example: 111222333

M 1 1 1 2 2 2 3 3 3

6. Press **[START]**.
When the line is connected, transmission begins automatically.

-
- When the SFX-110/210 is connected to PABX extension line, press the access number to PSTN and press **[REDIAL/P]** to enter a pause after placing the original document. Then press **[Mercury]** and dial party's phone number.
 - When **[Mercury]** key is pressed at a dialing, the one-touch and speed dial are not available. Use the number keys for entering the fax numbers.
 - If you need fax transmission after the telephone conversation, follow the procedure below.

1. Lift the handset (or press **speaker** key) before pressing **[Mercury]** at step 3 above.

2. Press **[Mercury]**.

3. Follow the procedures 4 and 5.

4. When the call is answered, talk to the party.
SFX-110: If you press **speaker** key at step 1, lift the handset.
SFX-210: If you press **speaker** key at step 1, speak towards the microphone.

5. Press **[START]**.

6. Replace the handset.

Thermal paper handling

Thermal paper is heat-sensitive. Follow the precautions below while handling it.

Storage precautions

Thermal paper will start to discolor gradually at about 70°C (158°F).

It should not be exposed to heat, humidity or light, even when not in use.

Take the following storage precautions.

1. Store in a dark, cool and dry place.

Avoid storing near heat-generating appliances or in enclosed places subject to high temperatures (the trunk of a car, for example.)

2. Once the package is opened, use the paper as soon as possible.

Handling precautions

1. If thermal paper is touched with sweaty hands, fingerprints or smeared images may result.
2. If thermal paper is rubbed against a hand, coloring may be caused by heat due to friction.
3. Coloring or erasure may occur if oil or other chemicals are allowed to come into contact with the paper.

Be careful in the following cases:

- When gluing, use only water-soluble glue (commercially available).
- When some adhesive tapes are used, coloring may result. The use of double-sided tapes on the back of the paper is recommended.
- When storing the paper in plastic cases, use those made of polyethylene, polypropylene or polyester.
(Do not use PVC cases.)
- Do not stack the paper along with polyvinyl chloride (PVC) films or heat-sensitive wax-type paper. The recorded images will fade, as these materials contain plastics.
- Do not stack the paper with diazo- or wet-type photocopies immediately after they have been copied on. Ammonia, etc., may cause discoloring.
- The paper will discolor if it comes into contact with alcohol or other volatile organic solutions.

4. Avoid exposing the paper to direct sunlight, as this tends to cause yellowing.

Jammed original

A beep sounds and display shows "ORIGINAL JAM", if an original document jams.
(If the **ERROR** lamp lights when the original jams, press **[STOP]** before operating below.)

1. Lift the operation panel forward.
2. Raise the document release lever.
3. Remove the jammed paper while pressing the green release lever.

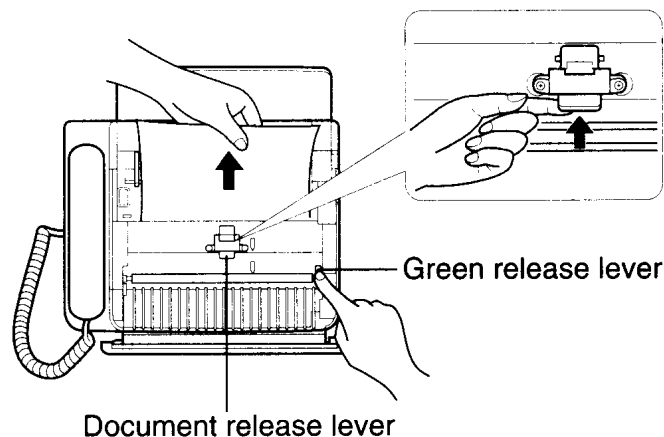

4. Reposition the release lever and close the operation panel.

Jammed recording paper

A beep sounds and display shows "CHECK PAPER ROLL", if the recording paper jams.

1. Open the original document tray.
2. Lift the operation panel forward.
3. Press **[OPEN]** button to open the recording paper cover.
4. Pull out the jammed section of the recording paper, and cut it off.
5. Reinsert the end of roll to recording paper exit.
6. Close the recording paper cover securely by pressing on the left and right front corners of the far end of the cover.
➔ The recording paper is cut automatically.

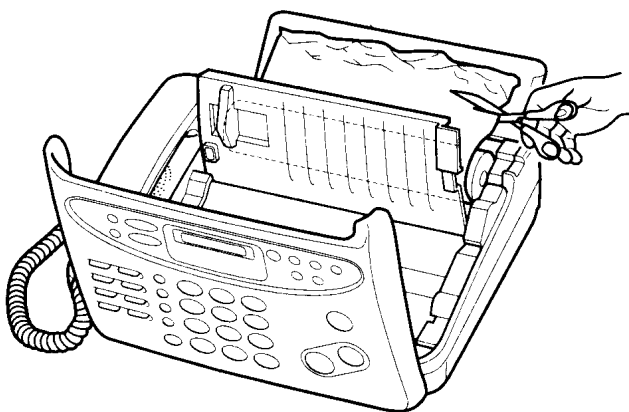

- If the paper cutter blade blocks the recording paper exit slot, place the end of the recording paper on the roller, then close the recording paper cover. Recording paper is automatically fed, and the extra paper is cut.

Mechanical error

When the display shows "MECHANICAL ERROR", operate the following procedure to clear the error.

(If the **ERROR** lamp also lights, press [**STOP**] before operating below.)

1. Open the original document tray.
2. Lift the operation panel.
3. Press [**OPEN**] button to open the recording cover.
4. If the cogwheel ① is stuck in the cogwheel ② as shown figure 1, lift the cogwheel ①.
(See figure 2)
 - The correct position of cogwheel ① and ② shows in the figure 3.
5. Reinsert the end of recording paper roll to recording paper exit.
6. Close the recording paper cover securely by pressing on the left and right front corners of the far end of the cover.
 - ➔ The recording paper is cut automatically.

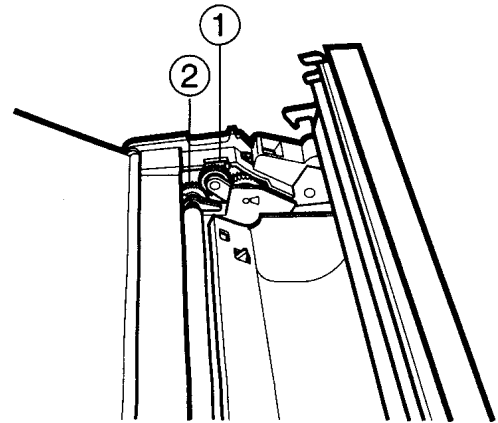

Figure 1

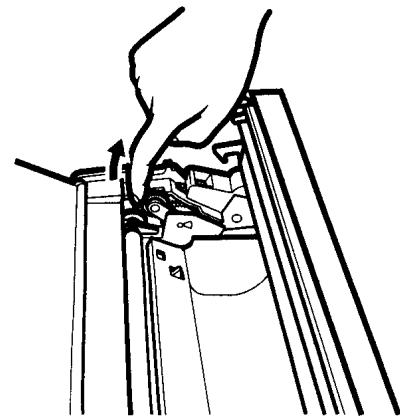

Figure 2

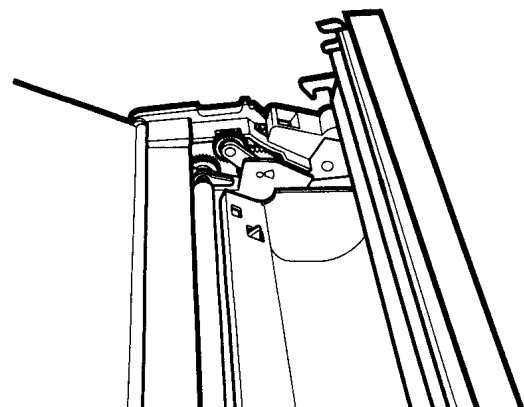

Figure 3

- If the "MECHANICAL ERROR" display cannot still be cleared, contact an authorized Sanyo service center.

Cleaning

Cleaning the housing (exterior plastic parts)

Gently wipe the housing with a soft, clean cloth dampened with a small amount of a neutral detergent.

- Do not use a cleaning agent such as alcohol or benzene.



Cleaning the document feed roller-2

If a streak or dirty pattern appears on a copy or a fax you have sent, clean the document feed roller-2 with a soft, clean cloth dampened with a small amount of neutral detergent.

1. Open the original document tray.
2. Open the operation panel.
3. In order to rotate the document feed roller-2, press the document sensor as shown in the illustration.
4. Clean the document feed roller-2, then dry it thoroughly to prevent the document from jamming.
5. Close the operation panel.

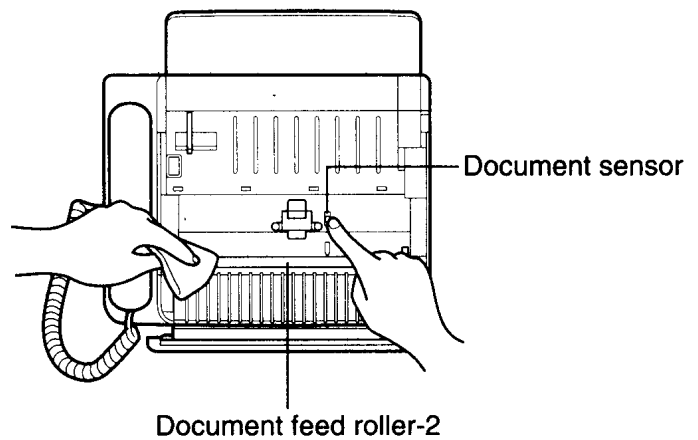

Cleaning the document feed roller-1

If the document jamming or overlapping frequently occurs, clean the document feed roller-1 with a cotton swab dampened with a small amount of a neutral detergent.

1. Open the original document tray.
2. Open the operation panel, and then raise the document release lever.
3. In order to rotate the document feed roller-1, press the document sensor as shown in the illustration.
4. Clean the document feed roller-1, then dry it thoroughly to prevent a document from jamming.
5. Reposition the release lever and close the operation panel.

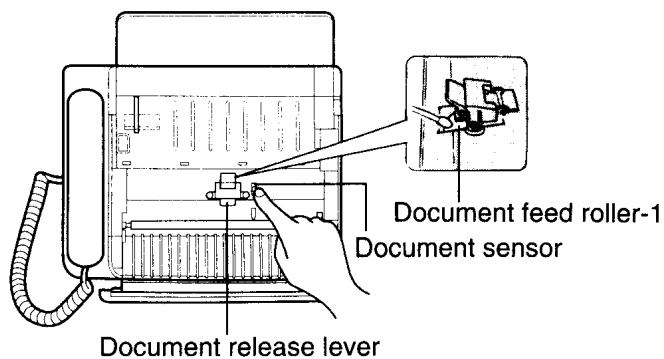

Troubleshooting

If problems occur during operation, check below before taking the unit for service. If the problem cannot be corrected, contact the dealer from whom the unit was purchased.

	Symptoms	Possible causes/solution	Page
General	Unit does not operate.	AC plug may not be connected to electrical outlet.	12
	The display indicates CHECK PAPER ROLL	Recording paper may not be set properly.	15
		Recording paper may have run out.	–
	Document cannot be inserted.	Document may be too thin or too thick.	29
		Another document may be jammed inside. Open operation panel and remove jammed document.	93
	You may have placed more than 10 sheets.	30	
Transmitting	Transmission is not possible.	Document may not be inserted far enough into the slot.	30
		Recording paper may have run out on receiving unit.	–
		Receiving unit may be set for manual reception.	–
Reception	Reception is not possible.	Unit may be set for manual reception. Lift the handset and incoming fax transmission can be received without pressing [START] key.	41
		Power cord may not be connected.	12
		Recording paper may have run out.	–
		Selective reception may be set to on. Check feature switch No. 26.	46
	Received copy is not dark enough.	The recommended recording paper is not used.	16
		Transmitted original may be light.	31
	Received copy is blank.	Recording paper may have been inserted upside down.	15
		Transmitted original may have been upside down.	–
	Received copy contains illegible/distorted characters.	Phone connection may have been poor. (If problem continues, contact dealer.)	–
Red line appears on recording paper	Recording paper has almost run out. Install a new recording paper roll.	15	

	Symptoms	Possible Causes/Solution	Page
Error lamp	Error lamp lights.	Press [STOP] to turn off the error light. May be a communication error due to a poor line connection.	–
Phone call	No dial tone when handset is picked up.	Telephone code may not be connected properly.	12
	Sound from speaker is too low.	Monitor volume switch may be set to lower position.	7
	No rings are heard.	Ringer volume switch may be set to "OFF".	7
	Fax/phone call does not connect to other party.	Wrong dialing mode may be set. Check the feature switch No.00.	14
Extension phone	Impossible to place phone call.	Fax possibly being transmitted or received.	–
	Telephone does not ring.	Too many phones may have been connected to the same line.	12
	Remote reception does not work.	Remote reception feature switch (No. 08) may have been set to off.	77
		If you have initiated the call from the extension phone, remote reception will not work.	–
Answering system	No messages recorded. (only for SFX-210)	The memory for answering system is full. (You have too many incoming messages.) Erase some or all messages.	52
		The message recording mode may be set to ANSWER only. Change it to VOX(3 MIN) or FIX 30 SEC.	56
	Your greeting cannot be recorded. (only for SFX-210)	The memory for answering system is full. (You have too many incoming messages.) Erase some or all messages.	52
		The fax telephone or extension telephone connected to the unit may be in use.	–
	Remote access operation does not work. (only for SFX-210)	You may be using a pulse-dialing phone. Call from a Touch-Tone dialing phone	54
		The [*] key may not be pressed correctly. Press it firmly. The 4-digit password may not be entered correctly.	54

Specifications

Model	SFX-110/210
Type	Desktop type transceiver
Line connected	Public switched telephone network
Size of recording paper	216 mm (8.5") x 30 m (98') / 25 m (82')*
Effective scanning width	208 mm (8.2")
Effective recording width	212 mm (8.3")
Transmission speed	9600/7200/4800/2400 BPS
Main scanning density	8 pels
Sub scanning density	3.85 lines/mm (Standard mode) 7.7 lines/mm (Fine mode) 15.4 lines/mm (Super fine mode)
Compression mode	MH (Modified Huffman) and Sanyo original
Reading method	Flat-bed by contact image sensor
Recording method	Flat-bed by thermal printing head
Power supply	AC 230V, 50 Hz
Power consumption	Stand-by: 7 W, Transmission: 20W, Reception: 85W, Copy: 75W
Overall dimensions	337(W) × 104(H) × 255(D) mm 13.3"(W) × 4.1"(H) × 10.1"(D)
Weight	Approx. 3.5 kg (7.7 lb)
Ambient temperature	5°C -35°C (41°F – 95°F)

* High-grade thermal paper comes as 25-m roll.

Optional accessories:

Part name	Part No.
Thermal paper (30m/98')	R-4079448-1
High-grade thermal paper (25m/82')	3RE2182800450

GUARANTEE TO CUSTOMER

Sanyo U.K. Sales Ltd. (the Company) guarantees to the initial retail purchaser that if this equipment is or becomes defective and that, in the opinion of the Company, the defect is due to faulty material or workmanship the Company will, for a period of 12 calendar months from the date of sale to the original purchaser repair or replace, at its sole option, free of charge, any such defective component part of the equipment, always provided that:-

1. The equipment has at all times been used in accordance with the operating instructions issued by the Company, and has not been connected to an electrical mains supply for which it has not been adjusted.
 2. Accidental damage, or damage caused by negligence or misuse by the user, including leakage from exhausted batteries, is specifically excluded.
 3. Unauthorised repairs, or any modification to the equipment which has not been expressly approved by the Company, shall render this guarantee null and void.
 4. Failure due to fair wear and tear of any item, such as batteries, record playing styli, and tape recording, playback and erase heads and head cleaning is specifically excluded.
-

This guarantee is not transferable and is only applicable within the United Kingdom (and the Republic of Ireland). Nothing in this express guarantee affects the statutory rights available to the purchaser of this equipment.

DEAR CUSTOMER

Thank you for buying Sanyo. This equipment should give you many years of pleasure and faithful service but in the event that a fault occurs, the following notes for your guidance may be helpful:-

1. PLEASE RETAIN YOUR PURCHASE RECEIPT WHICH WILL BE REQUIRED FOR SERVICE DURING GUARANTEE.
 2. If your Sanyo equipment proves faulty during the period guarantee, take it or send it back to the dealer who originally supplied it together with the guarantee and the proof of purchase. We have made arrangements with our approved dealers under which they will carry out in guarantee service repairs on our behalf. In this way, we hope to reduce to a minimum the amount of time you will be without your equipment.
 3. If for some reason it is impossible to return the equipment to the original supplier, please contact our Service Administration Department at the address below for further advice.
 4. Should the equipment require servicing after the expiry of the guarantee period, take or send it to the original supplier or any other Sanyo dealer. He will be pleased to give you a quotation for the repair. If you are in any doubt about what to do, write to us at the address below or telephone:
-

Sanyo U.K. Sales Ltd.

Sanyo House Otterspool way, Watford, Hertfordshire WD2 8JX Tel: Watford 246363

SANYO

9RE6P110A0230

SANYO Electric Co., Ltd.
Printed in China